



Professional Shop Manual



P61/P65/P70 Series Vertical Shaft Engines Second edition

NOTE: These materials are for use by trained technicians who are experienced in the service and repair of outdoor power equipment of the kind described in this publication, and are not intended for use by untrained or inexperienced individuals. These materials are intended to provide supplemental information to assist the trained technician. Untrained or inexperienced individuals should seek the assistance of an experienced and trained professional. Read, understand, and follow all instructions and use common sense when working on power equipment. This includes the contents of the product's Operators Manual, supplied with the equipment. No liability can be accepted for any inaccuracies or omission in this publication, although care has been taken to make it as complete and accurate as possible at the time of publication. However, due to the variety of outdoor power equipment and continuing product changes that occur over time, updates will be made to these instructions from time to time. Therefore, it may be necessary to obtain the latest materials before servicing or repairing a product. The company reserves the right to make changes at any time to this publication without prior notice and without incurring an obligation to make such changes to previously published versions. Instructions, photographs and illustrations used in this publication are for reference use only and may not depict actual model and component parts.

© Copyright 2008 MTD Products Inc. All Rights Reserved

MTD Products Inc - Product Training and Education Department

FORM NUMBER - 769-03354A

08/2008

Table of Contents

Chapter 1: Introduction	1
Professional Shop Manual intent	1
Assembly	1
Maintenance	3
Spark plugs	3
Air filters	4
Oil type and capacity	5
Changing the oil	5
Fuel	6
Fuel filters	7
Valve lash	7
Exhaust system	9
Cleaning the engine	9
General torque specifications	10
Maintenance Chart	10
Chapter 2: Basic Troubleshooting	11
Definitions	11
Introduction	11
Steps to troubleshooting	11
Define the problem	11
Identify factors that could cause the problem	12
Repairing the problem	16
Prime test	16
Leak-down test	17
Compression test	18
PCV testing	19
Chapter 3: Air Intake and filter	23
Air filters	23
Paper air filter	23
Foam air filter	24
Carburetor Insulator	26
Chapter 4: The Fuel System and Governor	29
Inspecting the fuel	29
Test fuel for alcohol	29
Fuel tank vent	30
To test the cap vent	30
The fuel filter	31
Inspect the fuel lines	31
The fuel tank	31
Evaporative (EVAP) emissions system	32
Charcoal canister fuel tank	34
Roll over valve vent	35

Charcoal canister	36
EVAP fuel tank	37
Manual Choke	38
Autochoke	38
1P61/1P65	39
1P70	39
Primer	40
Carburetors	41
Inspecting the carburetor	41
Disassembly and rebuilding the carburetor	42
Governor	46
Governor arm	46
Governor shaft	47
Governor cup and the governor gear	48
Chapter 5: Lubrication	51
Oil type and quantity	51
Oil dip stick	51
Dip stick tube removal	52
Lubrication system	52
PCV	53
Chapter 6: Starters	57
Recoil Starter Removal	57
Starter Cup	58
Starter Rope	59
Starter pulley and recoil spring	60
Electric starter relay	62
Testing the starter relay	63
Electric starter	65
Schematic	66
Chapter 7: Ignition System	67
Trouble shooting the ignition system	67
To test the stop switch	67
About the spark plug	72
Cleaning the spark plug	72
Inspection of the spark plug	72
Spark plug removal	72
Ignition module	73
Module removal	73
Installing the module and setting the air gap	73
Engine brake and stop switch (if equipped)	74
Adjusting the brake assembly (if equipped)	75
Flywheel	76
Chapter 8: Exhaust	79
To remove/replace the conventional muffler	79
Catalytic converter muffler	80

Chapter 9: Cylinder Head	83
Valves	85
Chapter 10: Crankshaft, piston and Connecting Rod	87
Crank shaft inspection	89
Piston Inspection	90
Connecting rod inspection	91
Cylinder inspection	92
Bearings	93
Reassembly	93
Engine specifications chart	97
Engine torque values chart	100
Chapter 11: Failure Analysis	101
Abrasive Ingestion	101
Insufficient lubrication	104
Engine Overspeed	105
Overheated	106
Mechanical Breakage/ Wear	107
Detonation/preignition	107

CHAPTER 1: INTRODUCTION

Professional Shop Manual intent

This manual is intended to provide service dealers with an introduction proven diagnostic and repair procedures for the MTD vertical shaft engines.

Disclaimer: The information contained in this manual is correct at the time of writing. Both the product and the information about the product are subject to change without notice.

About the text format:

NOTE: is used to point-out information that is relevant to the procedure, but does not fit as a step in the procedure.

CAUTION: is used to point-out potential danger to the technician, operator, bystanders, or surrounding property.

- Bullet points: indicate sub-steps or points.

Disclaimer: This manual is intended for use by trained, professional technicians.

- Common sense in operation and safety is assumed.
- In no event shall MTD or Cub Cadet be liable for poor text interpretation, or poor execution of the procedures described in the text.
- If the person using this manual is uncomfortable with any procedures they encounter, they should seek the help of a qualified technician.

Fasteners

- Most of the fasteners used on the MTD engine are metric. Some are fractional inches. For this reason, wrench sizes are frequently identified in the text, and measurements are given in U.S. and metric scales.
- If a fastener has a locking feature that has worn, replace the fastener or apply a small amount of releasable thread locking compound such as Loctite® 242 (blue).
- Some fasteners like cotter pins are single-use items that are not to be reused. Other fasteners such as lock washers, retaining rings, and internal cotter pins (hairpin clips) may be reused if they do not show signs of wear or damage. This manual leaves that decision to the judgement of the technician.

Assembly

Torque specifications may be noted in the part of the text that covers assembly. They may also be summarized in tables along with special instructions regarding locking or lubrication. Whichever method is more appropriate will be used. In many cases, both will be used so that the manual is handy as a quick-reference guide as well as a step-by-step procedure guide that does not require the user to hunt for information.

The level of assembly instructions provided will be determined by the complexity of reassembly, and by the potential for unsafe conditions to arise from mistakes made in assembly.

Some instructions may refer to other parts of the manual for subsidiary procedures. This avoids repeating the same procedure two or three times in the manual.

Chapter 1: INTRODUCTION

MTD Vertical Engine Model Designators

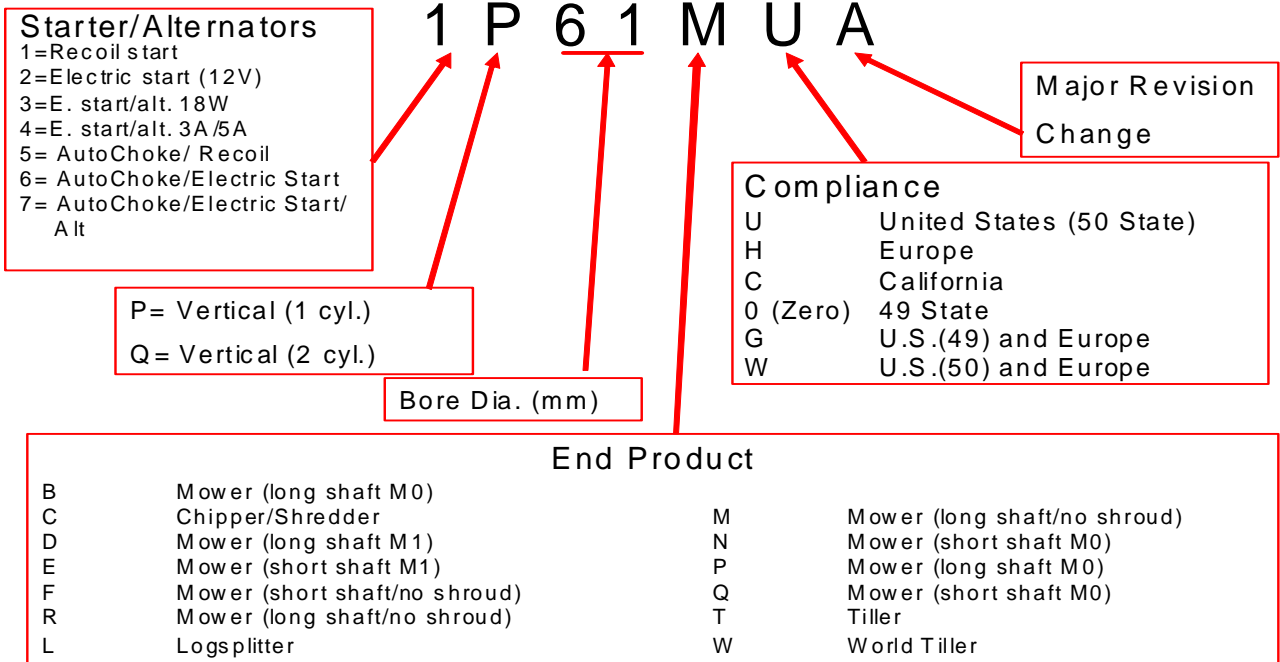

MTD Engine Serial Numbers

1P65FH/0510271A0023

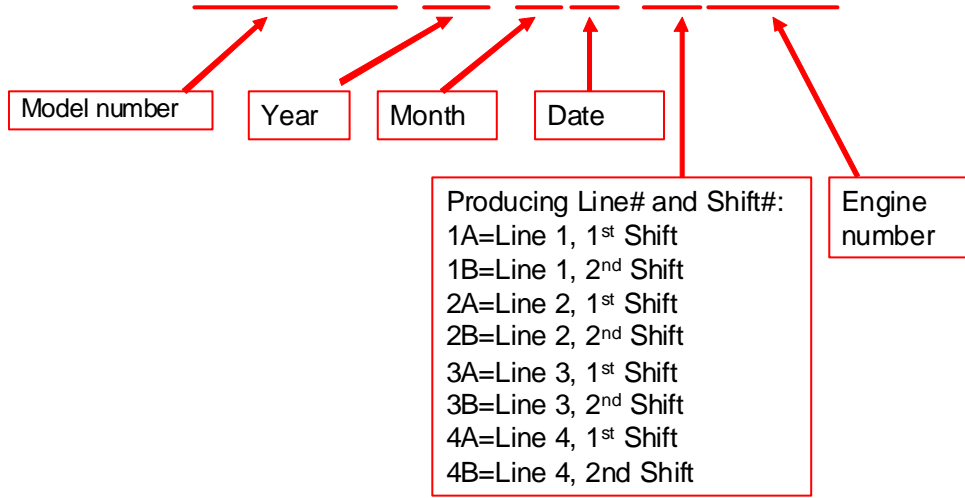

MAINTENANCE

The information in this manual applies to the MTD engine. Some basic principles may apply to engines produced by other manufacturers.

As the saying goes “an ounce of prevention is worth a pound of cure”. The same can be said about preventive maintenance on outdoor power equipment. By changing the spark plug, air filter, and oil at recommended intervals many failures can be avoided. Sometimes just clearing off yard debris that has collected through use can make the difference between a properly running piece of equipment and the expensive inconvenience of unplanned repairs..

Spark plugs

1. The spark plug used in the MTD engine is a Torch model F6RTC gapped to .024”-.032” (.60-.80 mm). See Figure 1.1.



Figure 1.1

NOTE: Champion RN14YC or NGK BPR4ES are physically similar but do not match the F6RTC in heat range. This difference in heat ranges will effect performance and emissions. It is recommended that only the torch F6RTC plug be used in MTD engines.

2. Wear rate will vary somewhat with severity of use. If the edges of the center electrode are rounded-off, or any other apparent wear / damage occurs, replace the spark plug before operating failure (no start) occurs.
3. Cleaning the spark plug:
NOTE: It is not recommended to clean spark plugs. Use of a wire brush may leave metal deposits on the insulator that causes the spark plug to short out and fail to spark. Use of abrasive blast for cleaning may cause damage to ceramic insulator or leave blast media in the recesses of the spark plug. When the media comes loose during engine operation, severe and non-warrantable engine damage may result.
4. Inspection of the spark plug can provide indications of the operating condition of the engine.
 - Light tan colored deposits on insulator and electrodes is normal.
 - Dry, black deposits on the insulator and electrodes indicate an over-rich fuel / air mixture (too much fuel or not enough air)
 - Wet, black deposits on the insulator and electrodes indicate the presence of oil in the combustion chamber.
 - Heat damaged (melted electrodes / cracked insulator / metal transfer deposits) may indicate detonation.
 - A spark plug that is wet with fuel indicates that fuel is present in the combustion chamber, but it is not being ignited.

Chapter 1: INTRODUCTION

Air filters

The main function of the air filter is to trap air borne particles before they reach the carburetor that can cause catastrophic internal engine damage.

MTD vertical shaft engines use two different air filters. The first is a rectangular paper pleated filter with a foam pre-filter. the second is an oval foam filter. See Figure 1.2.

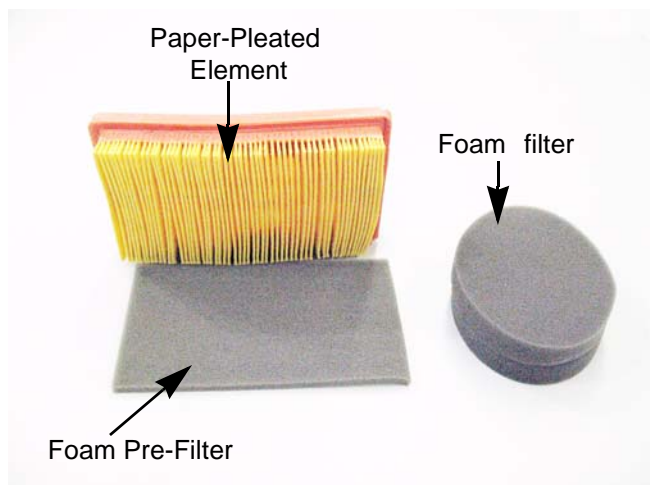

Figure 1.2

5. Air filters used on the MTD engine are designed to prevent particles larger than 3-5 micron from passing through into the engine.
6. The filter should be checked on a regular basis possibly several times in a season. See Figure 1.3.



Figure 1.3

7. Typically an air filter should be changed, or cleaned if it is a foam one, before every season.
8. If a foam air filter or pre-cleaner is dirty and not in to bad of condition it can be cleaned and reused. The paper pleated filters can be shaken or lightly tapped to free the debris from the filter.
NOTE: Never use compressed air on a paper air filter. Compressed air will remove the tiny fibers that are used to catch the dirt in the air. Without these fibers the filter is useless.
9. Foam filters and pre-filters can be washer in warm soapy water.
NOTE: When drying a foam filter either squeeze it in side of a paper towel or let it air dry DO NOT wring it because the filter will tear.
10. Before installing any foam filter, after it has been washed, it needs to be free of moisture.
NOTE: Always check with factory specification prior to servicing/replacing any engine components.

Oil type and capacity

1. When checking the oil twist and remove the dipstick from the engine. Clean the oil off of the tip of the dipstick. Re-insert the dipstick **without** threading it in to get the oil level reading. See Figure 1.4.



Figure 1.4

- SAE 10W-30 oil with a SF/CD API rating or better is recommended for most operating conditions up to 97° F (36° C).
 - The oil capacity is 17.0- 20.3 fl.oz (0.5-0.6 liters).
 - 2. The oil level is determined by the lowest point on the dipstick that is completely covered with oil.
 - 3. If the oil is noticeably thin, or smells of gasoline, a carburetor repair may be needed before the engine can be safely run.
 - Check the oil level frequently and change the oil more frequently in severe operating conditions such as high ambient temperature, dusty conditions, or high load use in exceptionally thick grass.
 - Synthetic oil is a suitable alternative, but it does not extend service intervals.
- NOTE:** MTD recommends the use of petroleum oil during the break in period to ensure the piston rings correctly break in.
- Synthetic vs. Petroleum based oil: To simply look at synthetic oil and to compare it with Petroleum based oil there is very little difference. However, when you look at the two through a microscope it is easy to see the difference. Synthetic is made up of smaller molecules. This allows the oil to get into areas that petroleum based oil cannot.

- No oil additives or viscosity modifiers are recommended. The performance of a good oil meeting the API specifications will not be improved by oil additives.
- Some oil additives may cause severe and non warrantable engine damage, constituting a lubrication failure. No oil additives or viscosity modifiers are recommended. The performance of a good oil meeting the SF/ CD specifications will not be improved by the addition of any oil additives.

NOTE: Some oil additives may cause severe and non warrantable engine damage, constituting a lubrication failure.

Changing the oil

NOTE: If the engine has been running, allow the engine to cool before doing any maintenance work.

NOTE: The oil should be changed after the first 5 hours of operation and every 25 hours there after.

There are two methods of changing the oil. The application the engine is mounted to will determine which method to use:

1. The first method of draining the oil is by removing the drain plug located at the base of the filler tube / dipstick tube, using a 10mm wrench. See Figure 1.5.

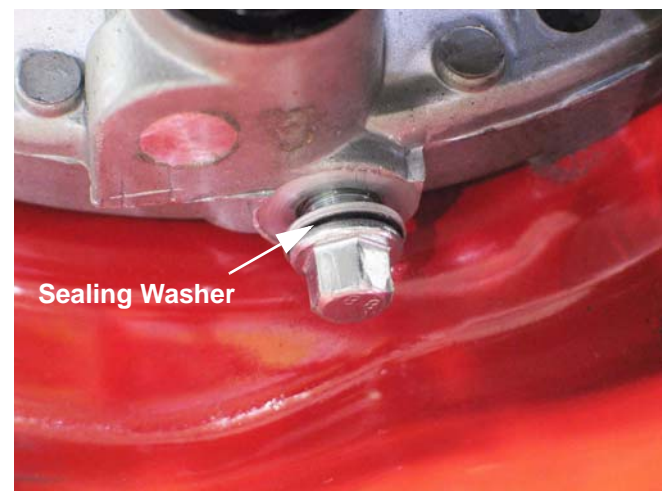

Figure 1.5

NOTE: Replace the drain plug sealing washer with a new one to ensure that it does not leak.

NOTE: Tighten the drain plug to a torque of 84 in. lbs. (10Nm) on installation.

Chapter 1: INTRODUCTION

2. The second method for draining the mower engine oil is to tip the mower on its side, dipstick tube down and dipstick removed, draining the oil into a waste oil pan.
 - 2a. Disconnect the spark plug lead and ground it to the engine block.
 - 2b. Lean the mower to the muffler side of the engine. See Figure 1.6.



Figure 1.6

Fuel

Gasolines currently on the market are not pure gas. Today's fuels have alcohol and other additives in them to reduce emissions. The fuel make up can vary seasonally and geographically.

Fuel with alcohol added to it is sometimes referred to as "oxygenated fuel". The extra oxygen carried by the ethanol increases the oxidation of the fuel. This speeds up the process that causes the fuel to go bad.

Excessive alcohol in fuel creates a lot of problems for gasoline engines. One of the biggest problems is that alcohol attracts and holds water. This corrodes the metal components of the fuel system, especially the carburetor. Alcohol also does not produce as much heat as gasoline when burnt. This results in less power for the engine.

A 10% alcohol mix (E10) is acceptable for MTD engines. Anything higher than that will result in performance and starting issues.

NOTE: E85 and E20 fuels are not to be used in any MTD engines.

- Use clean, fresh fuel with a pump octane rating of 87 or greater.
- Stale or out-of-date fuel is the leading cause of hard starting issues.
- Use of a high octane fuel may improve performance in areas using high alcohol fuel blends.

Fuel filters

Dirty fuel can clog the carburetor and introduce abrasive materials into the engine. To help prevent that, the MTD engine is equipped with a fuel filter.

1. Some of the early engines were equipped with a fuel filter placed between the fuel tank and the carburetor. See Figure 1.7.

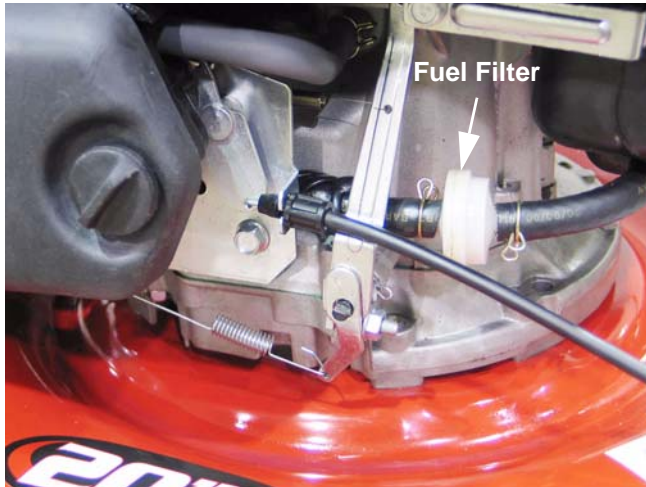

Figure 1.7

2. Currently the engines are equipped with a fuel filter installed in the fuel tank where the fuel line connects. See Figure 1.8.



Figure 1.8

Valve lash

Valve lash is the clearance between the top of the valve stem and the rocker arm. The valve lash should be checked after the first 25 hours of use and every 100 hours after that. Valve lash can be checked and adjusted using the following steps:

1. If the engine has been run, allow it to cool thoroughly. Position the mower for easy access to the cylinder head.
2. Disconnect the high-tension lead from the spark plug and ground it well away from the spark plug hole.
3. Remove the spark plug using a 13/16" or 21mm wrench. A flexible coupling or "wobbly" extension may help. See Figure 1.9.

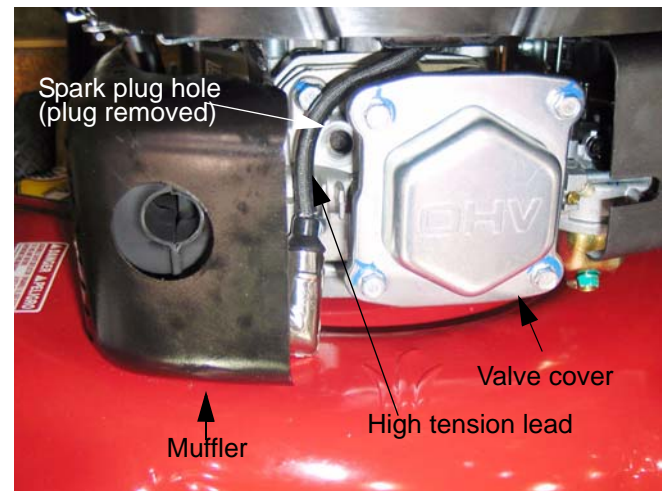

Figure 1.9

4. Remove the four bolts that secure the valve cover using a 10mm wrench, and remove the valve cover from the engine.
NOTE: If care is used, not to damage the valve cover gasket, it can be re-used.
5. Secure the safety bale with a spring clamp (if installed on a mower), and slowly pull the starter rope until air can be heard being expelled from the spark plug hole.

Chapter 1: INTRODUCTION

6. Confirm that the piston is at Top-Dead-Center on the compression stroke. See Figure 1.10.



Figure 1.10

- The compression stroke can be distinguished from the overlap stroke by the presence of air pressure at the spark plug hole and the fact that neither of the valves should move significantly on the compression stroke.
 - There is an automatic compression release mechanism that “bumps” the exhaust valve as the piston rises on the compression stroke. At TDC, the exhaust valve should be fully closed.
7. Check valve lash between each valve stem and rocker arm using a feeler gauge.
 8. Intake valve lash (top valve) should be .003”-.005” (.10 ± .02mm). See Figure 1.11.



Figure 1.11

9. Exhaust valve lash (bottom valve) should be .005-.007” (.15 ± .02mm). See Figure 1.12.

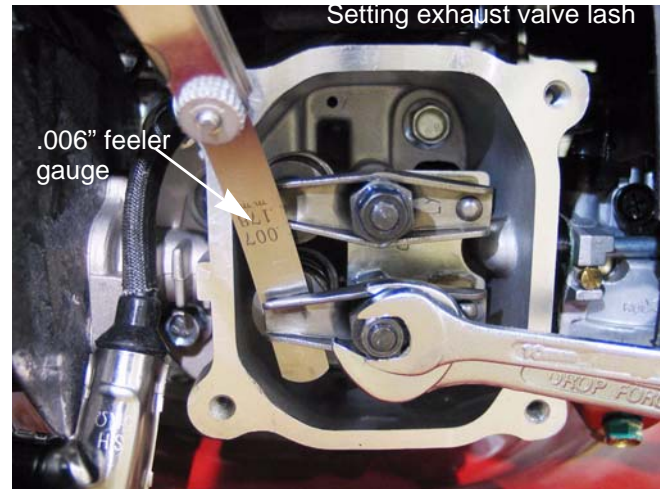

Figure 1.12

10. Use a 10mm wrench to loosen the jam nut, and a 14mm wrench to adjust the rocker arm fulcrum nut. See Figure 1.12.
- Tighten the rocker arm fulcrum nut to close-up the clearance between the end of the valve stem and the contact point on the rocker arm.
- Loosen the rocker arm fulcrum nut to open-up the clearance between the end of the valve stem and the contact point on the rocker arm.
11. Hold the fulcrum nut with a 14mm wrench, tighten the jam nut to a torque of 88.5 in-lb. (10Nm) using a 10mm wrench.
12. Double-check the clearance after tightening the jam nut, to confirm that it did not shift. Re-adjust if necessary.
13. Rotate the engine through several compression cycles:
 - Observe the movement of the valve gear.
 - Return the piston to TDC compression stroke and re-check the valve lash to confirm consistent movement of the valve gear, including the slight bump to the exhaust valve from the automatic compression release.
14. Clean-up any oil around the valve cover opening, clean the valve cover, replace the valve cover gasket if necessary.
15. Install the valve cover, tightening the valve cover screws to a torque of 71 in-lbs (8 Nm).

IMPORTANT: Over tightening the valve cover will cause it to leak.

16. Install the spark plug.
17. Release the spring clamp securing the safety bail, start the engine and test run it long enough to confirm correct operation.

Exhaust system

The exhaust system is a frequently overlooked component of an engine. It is important to make sure the muffler is in good condition and free of blockage.

NOTE: A blocked muffler will result in poor performance. If a muffler is completely blocked the engine may not start.

Cleaning the engine

1. To maintain a proper operating temperature and to keep the equipment looking good all debris should be removed from the engine.
2. It is recommended to use compressed air to blow all of the debris off of the engine.

NOTE: A pressure washer may be used to clean outdoor power equipment **but only** after the unit has been allowed to properly cool.

NOTE: Debris can build up under the deck and cause the engine to operate under an unintended load.

Chapter 1: INTRODUCTION

General torque specifications

	size	M4	M5	M6	M8	size	M10	M12	M14
Grade 4.8	in-lbs	11	22	38	93	ft-lbs	16	27	43
	Nm	1.2	2.5	4.3	10.5	Nm	21.7	36.6	58
5.8	in-lbs	15	28	50	120	ft-lbs	20	35	55
	Nm	1.7	3.2	5.7	13.6	Nm	27.1	47.5	76
8.8	in-lbs	26	51	88	216	ft-lbs	35	61	97
	Nm	2.9	5.8	9.9	24.4	Nm	47.5	82.7	132
10.9	in-lbs	36	72	124	300	ft-lbs	49	86	136
	Nm	4.1	8.1	14	33.9	Nm	66.4	116.6	184
12.9	in-lbs	44	86	146	360	ft-lbs	60	103	162
	Nm	5	9.7	16.5	40.7	Nm	81.4	139.7	220
Noncritical Fasteners in Aluminum	in-lbs	18	35	60	150	ft-lbs	25	45	70
	Nm	2	4	6.8	17	Nm	33.9	61	95

Maintenance Chart

Maintenance item	Each use	Each 25 hrs. use	Each 50 hrs. use
Check oil	*		
Check air filter (If applicable)	*		
Note on air filter	Dirt may be shaken or tapped out of the air filter, but compressed air is not to be used for cleaning. Do not wash or oil paper filter element.		
Note on pre-filter	Foam pre-filter may be washed in water and mild detergent, and re-used. Do not oil.		
Check & gap spark plug	Replace if worn.		*
Check cooling fins	After prolonged storage		
Check/clean spark arrestor		*	
Change oil		*	
Note on oil:	Change oil after first 5 hrs. of use, and before prolonged storage.		
Change air filter		*	
Note on air filter	Air filter and pre-filter life vary dramatically with operating conditions.		
Drain or preserve fuel	Before prolonged storage		
Fog or lube cylinder	Before prolonged storage		
Rotate engine to TDC	Before prolonged storage		

CHAPTER 2: BASIC TROUBLESHOOTING

Definitions

Troubleshooting - The act gathering information by performing tests and direct observations.

Diagnosis - A theory of what the problem is based on the information gathered by troubleshooting.

Introduction

Diagnosing an engine is an art form that is built upon several factors. First and most importantly is a good understanding of how the engine works. The second is skills that have been honed by experience. Finally the use of visual observations and a structured, systematic approach to troubleshooting a problem.

The first part of this chapter will outline the steps of troubleshooting an engine so a technician can form a proper diagnosis. The second half of this chapter will describe specific procedures and tests to perform while troubleshooting.

CAUTION: The first two rules in troubleshooting is to cause no further harm to the engine and prevent injuries. Always make sure to check the oil for level and condition before starting an engine. Also check attachments for damage and make sure they are firmly mounted.

Steps of troubleshooting

NOTE: The steps and the order of the steps that follow are a suggested approach to troubleshooting the MTD engine.

Define the problem

The first step in troubleshooting is to define the problem:

- Crankshaft will not turn.
 - a. Hard to pull rope, steady pressure
 - b. Rope jerks back
 - c. Rope will not pull at all
- Crankshaft turns, no start
- Starts, runs poorly
 - a. Starts, then dies
 - b. Runs with low power out put
 - c. Makes unusual smoke when running
 - I. Black smoke, usually heavy
 - II. White smoke, usually heavy
 - III. Blue smoke. usually light
 - d. Makes unusual sounds when running
 - I. Knock
 - II. Click
 - III. Chirp
 - IV. Unusual exhaust tone

There are tools that the technician can use in order to define the problem, such as:

1. Interview the customer.
 - 1a. Get a good description of their complaint.
 - 1b. If it is an intermittent problem, verify what conditions aggravates the problem as best as possible.
 - 1c. Get an accurate service history of the equipment.
 - 1d. Find out how the customer uses and stores the equipment.
2. Direct observation:
 - 2a. Do not take it that the customer is correct with their description of the problem. Try to duplicate the problem.
 - 2b. Check the general condition of the equipment (visually).

Chapter 2: Basic Troubleshooting

- I. Cleanliness of the equipment will indicate the level of care the equipment has received.
- II. Make sure the engine and attachments are securely fastened.
- III. The tune-up factors.

NOTE: Most hard starting and poor running conditions can be solved by performing a tune-up.

- a. Check the condition and amount of oil in the crankcase.
 - b. Check the level and condition of the fuel.
 - c. Check the air filter and look for signs of dirt ingestion.
 - d. Check the ignition and “read” the spark plug.
 - e. Look for obvious signs of physical damage, bent blade, exhaust system blockage or cooling system blockage.
3. Broken starter rope.
 - 3a. Usually means the engine was hard to start.
 - 3b. Makes it impossible to confirm any running or hard starting symptoms by direct observation.
 - 3c. Some inference can be made from checking other factors of the general condition of the equipment.

Identify factors that could cause the problem

This is the second step in the troubleshooting process.

1. Crankshaft will not turn.
 - a. Hard to pull rope, steady pressure. This usually indicates a mechanical bind of some sort. The likely suspects are:
 - I. A slightly bent crankshaft. In some cases the drag may increase and decrease as the crankshaft rotates. This produces a pulsing feeling that is different than a jerk back.
 - II. A parasitic load from a drive belt that is not releasing or an implement that is jammed.
 - III. An internal drag from a scored or seized piston.
 - b. Rope jerks back. This usually indicates that the piston is stopping before top dead center on the compression stroke and is being driven back down by compression or combustion. The likely suspects are:
 - I. Compression that is unusually high.
 - a. valve lash.
 - b. a partial hydraulic lock.
 - II. Ignition timing is advanced.
 - a. Improper air gap.
 - b. Sheared or missing flywheel key.
 - c. The wrong flywheel or module is installed on the engine.
 - III. Insufficient inertia to overcome normal compression.
 - a. Loose implement or blade.
 - b. A light flywheel used on a heavy flywheel application.
 - c. Rope will not pull at all. This is usually either a quick fix or a catastrophic failure. The likely suspects are:
 - I. A broken starter recoil (easy fix).
 - II. Complete hydraulic lock (easy fix).
 - III. External binding/jammed implement (easy fix).

Chapter 2: Basic Troubleshooting

- IV. Bent crankshaft (unrepairable)
 - V. Internal binding, crankshaft, connecting rod or piston (unrepairable)
2. Crankshaft turns, no start.
- 2a. Most gasoline engine diagnosis involves isolating problems in the four critical factors an engine needs to run properly:
- I. Ignition- sufficient spark to start combustion in the cylinder, occurring at the proper time.
 - II. Compression- enough pressure in the cylinder to convert combustion into kinetic motion. It also needs sufficient sealing to generate the vacuum needed to draw in and atomize the next intake charge.
 - III. Fuel- correct type and grade of fresh gasoline; in sufficient quantity, atomized (tiny droplets) and in correct fuel/air proportions.
 - IV. Flow- if all of the above conditions are met, but the flow of air is constricted on the inlet or exhaust side it will cause the engine to run poorly or not at all. This also includes ensuring the valves are timed to open at the proper time.
- 2b. Isolate the ignition system and compression from the fuel system by performing a prime test.
- I. Burns prime and dies. This would indicate a fuel system issue.
 - II. Does not burn prime. Not a fuel system issue. Check for an ignition, compression or flow problem.
- 2c. Compression or ignition problem
- I. Check the engine stop and/or ignition switch.
 - II. Test the ignition system using a proper tester.
 - III. Replace the spark plug with a new one or a known good one.
 - IV. Check compression or leak down.
 - V. Check valve lash.
 - VI. Check valve timing/actuation.
 - VII. Check exhaust.
3. Starts, runs poorly
- 3a. Starts, then dies
- I. Run the engine with a spark tester in-line between the spark plug wire and the spark plug or use an oscilloscope and see if the spark goes away at the same time the engine dies.
 - II. Check choke operation.
 - a. Black smoke?
 - b. Wet plug?
 - III. Test for invisible damage to the air filter by starting the engine with the air filter removed.
 - IV. Prime test immediately after engine dies. If it restarts; this may indicate a problem with fuel flow to the carburetor. Check the gas cap, fuel line, fuel filter, and the float in the carburetor.
- 3b. Runs with low power output.
- I. Look for unusual exhaust color (smoke).
 - II. Unusually hot muffler (may glow red).
 - a. Retarded ignition
 - b. Exhaust valve opening early (lash too tight)
- III. Mechanical bind
- a. A slightly bent crankshaft. In some cases the drag may increase and decrease as the crankshaft rotates. This produces a pulsing feeling that is different than a jerk back.
 - b. Parasitic external load. A bind in the equipment the engine is powering.
 - c. Internal drag from a scored piston or similar damage.
- IV. Low governor setting or stuck governor.
- a. Check RPMs using a tachometer.
 - b. RPMs should not droop under moderate to heavy loads.

Chapter 2: Basic Troubleshooting

V. Low compression

- a. Check valve lash
- b. Check compression
- c. Check leak down to identify the source of the compression loss.

VI. Flow blockage

A. Exhaust blockage, usually accompanied by an unusual exhaust sound.

- Just as a throttle on the carburetor controls the engine RPMs by limiting the amount of air an engine can breathe in, an exhaust blockage will limit engine performance by constricting the other end of the system.
- The muffler itself may be blocked.
- The exhaust valve may not be opening fully, possibly because of extremely loose valve lash settings.
- The exhaust valve seat may have come loose in the cylinder head. This may cause a loss of compression, a flow blockage or it may randomly alternate between the two.

NOTE: The cause of an exhaust valve coming loose is usually over heating.

B. Intake blockage

- An intake blockage up-stream of the carburetor will cause a rich fuel/air mixture and constrict the amount of air that the engine can draw in, limiting performance.

NOTE: A blocked air filter is a common cause of this.

- The intake valve not fully opening. A possible cause of this is loose valve lash.

C. Makes unusual smoke when running

- a. Black smoke, usually heavy usually indicates a rich air fuel mixture
- Not enough air: air filter blockage or a partially closed choke.
- Too much fuel: carburetor float or

float valve stuck or metering / emulsion issues with the carburetor.

b. White smoke, usually heavy

- Oil in muffler, usually the result of improper tipping. the engine will "fog" for a minute or so, then clear-up on its own.
- Massive oil dilution with gasoline. It may be caused by improper tipping. It can also be caused by leaky carburetor float valve, if there is a down-hill path from the carb. to the intake port. Check oil for gasoline smell, repair carburetor.

c. Blue smoke, usually light.

1 PCV system

- May be blocked or unplugged.
- May be over-come by massive over-filling or oil dilution with gasoline.
- Will cause oil to exit the engine via any low-resistance paths.

2 Piston rings

- Confirm with leak-down test.
 - Smoke will be more pronounced under load.
 - Repair may not make economic sense.
- ##### 3 Valve guides (and intake valve stem seal).
- Smoke will be more pronounced on over-run.

A. Makes unusual noise when running

a. Knock

- Check for loose mounting of engine or driven implement
- Rotate crankshaft back-and-forth to check for loose connecting rod.

b. Click

- Clicks and pops on engine shut-down: Compression release com-

Chapter 2: Basic Troubleshooting

ing into play as the engine RPMs cross the activation threshold. This will have no ill effects on engine performance.

- Half-engine speed clatter: loose valve lash.
 - Half-engine speed clatter, slightly heavier: wrist-pin.
 - Rhythmic heavy-light engine speed click: piston slap
- c. Spark-knock
- Advanced ignition timing
 - Low octane fuel
 - Over-heating engine (check for blocked cooling air flow)
 - Carbon build-up in cylinder: glowing carbon chunks pre-igniting air fuel mix.
- d. Chirp
- Compression, blowing-by the firing of a damaged head gasket will sometimes produce a chirping noise.
 - Confirm with a compression test and leak-down test.
- e. Unusual exhaust tone
- 1 Splashy, blatty, wheezing or whistling.
- Splashy or blatty idle usually indicates a slightly rich condition.
 - Whistling or wheezing may indicate an exhaust blockage, usually slightly muffled.
- 2 Backfire
- On over-run: unburned fuel igniting past exhaust valve. Mixture not burning completely in combustion chamber. It may be too rich or it may be a spark plug or an ignition problem.
 - Occasional, under load: engine momentarily runs lean, usually will cycle with float bowl level or governor pull-in, sometimes sounds like a slight stumble. Ethanol content

exceeding 10% will make the engine run artificially lean.

- c. Skip
- Usually ignition related.
 - Run the engine with a spark tester in-line between the spark plug wire and the spark plug or use an oscilloscope and see if the spark goes away at the same time the engine dies.

E Engine over-speed

- a. Continual over-speed
- Binding or damaged external governor linkage or carburetor throttle.
 - Mis-adjusted governor arm.
 - Internal governor failure.
- b. Momentary over-speed
- Intermittent bind (very unusual).
 - Interference: This is fairly common when debris can fall on the governor linkage during normal operations.

F Engine RPMs surge (hunting)

- a. Over-governed condition- Return spring replaced with wrong part or hooked into wrong hole.

NOTE: This is an extremely rare condition, usually created by tampering.

- b. Lean Air-fuel mixture condition- When AFR (Air Fuel Ratio) is significantly below stoichiometric ratio (14.7:1) engine RPMs sink until they reach a point that can be supported by the available fuel. This causes a momentary surge in power until the available fuel is consumed, then the RPMs fall again, repeating the cycle.
- Too much air: look for an air leak in the intake tract
 - Not enough fuel: look for fuel supply or carburetor problems

Chapter 2: Basic Troubleshooting

Repairing the problem

The third step in the troubleshooting process is to repair the problem. This step consists of:

1. Form a diagnosis by using all of the information gathered from the troubleshooting that was performed.
2. Physically perform the repair.

The fourth, and hopefully final, step in the troubleshooting process is the follow through. This step consists of:

1. Thoroughly test the repaired equipment: confirming that the initial diagnosis was correct. If it was wrong start the troubleshooting process over again.

NOTE: Sometimes the engine will have multiple problems at the same time. By performing one repair, other issues may show up that are unrelated to the first repair.

2. Delivery to customer: We are not just repairing equipment, we are repairing customers.
 - A. Inoculate against recurring problem with education, e.g... if the problem was caused by stale fuel, make sure the customer is aware that fuel goes bad over time.
 - B. Make sure the customer understands the repair, preventing "superstitious" come-backs.

Prime test

To perform a prime test:

1. Prime the engine through the carburetor throat using a squirt bottle, filled with clean fresh gasoline.

NOTE: Inspect the air filter while priming the engine. Look for a dirty or plugged filter that could prevent air flow or a missing filter that would indicate dirt ingestion.
2. Make sure the ignition switch or safety bail is in the run position.
3. Attempt to start the engine.
4. If the engine starts and runs long enough to burn the prime, the problem is effectively isolated to the fuel system. proceed to Chapter 4: The Fuel System and Governor.
5. Check ignition system as described in Chapter 7: Ignition System.

If the ignition system is working, check the compression or perform a leak down test.

Chapter 2: Basic Troubleshooting

Leak-down test

A leak-down test is the preferred method to test the engine's ability to compress the charge. It will also show where pressure is leaking from.

To perform a leak-down test:

NOTE: A leak down test pressurizes the combustion chamber with an external air source and will allow the technician to listen for air "leaking" at the valves, piston rings and the head gasket.

NOTE: These are general instructions. Read and follow the instructions that came with the tester before attempting to perform this test.

- If possible, run the engine for 3-5 minutes to warm up the engine.
- Remove the spark plug and air filter.
- Find top dead center of the compression stroke.

CAUTION: If the engine is not centered at top dead center, the engine will rotate when compressed air is introduced to the combustion chamber.

1. Find top dead center by following the steps described in the valve lash section of Chapter 1: Introduction
2. Thread the leak down tester adapter into the spark plug hole. See Figure 2.1.



Figure 2.1

3. Connect tester to compressed air.
4. Adjust the regulator knob until the needle on the gauge is in the yellow or set area of the gauge.
5. Connect the tester to the adapter.
NOTE: If the engine rotates it was not at top dead center.
6. Check the reading on the gauge.
7. Compare the results to the following chart. See Table 1.

Table 1:

Symptom	Possible cause
Air escaping from the breather	Worn cylinder or piston rings. Possible blown head gasket
Air escaping from the exhaust	Leaking exhaust valve
Air escaping from the carburetor	Leaking intake valve
Gauge reading low	Cylinder and piston rings are in good condition
Gauge reading moderate	There is some wear in the engine, but it is still usable
Gauge reading high	excessive wear of cylinder and/or piston rings. Engine should be short blocked or it could be a blown head gasket.

Chapter 2: Basic Troubleshooting

Compression test

To perform a compression test:

NOTE: Compression should be in the range of 45-95 PSI (3.1-6.5 Bar).

- Disconnect the high-tension lead from the spark plug and ground it well away from the spark plug hole.
- Remove the spark plug using a 13/16" or 21mm wrench. A flexible coupling or "wobbly" extension may help.
- Pull the starter rope several times to purge any fuel or oil from the combustion chamber.

NOTE: Air compresses readily, liquid does not. Liquid in the combustion chamber will result in an artificially high compression reading.

1. Install a compression gauge in the spark plug hole.
2. Confirm that the gauge is "zeroed", then pull the starter rope repeatedly, until the needle on the gauge stops rising. See Figure 2.2.



Figure 2.2

3. Interpreting compression readings.

Table 2:

Readings in psi	Possible causes
<20 (1.38 Bar)	Most likely a stuck valve or too tight of a valve lash, provided the starter rope pulls with normal effort.
20-35 (1.38-2.4 Bar)	Valve seat damage or piston ring and/or cylinder wear.
35-95 (2.4-6.5 Bar)	Normal readings
>95 (>6.5 Bar)	Excessive valve lash, a partial hydraulic lock, a bad cam or a bad automatic compression relief.

Chapter 2: Basic Troubleshooting

PCV testing

The PCV valve is located under the flywheel and allows the crankcase pressure to escape.

Leakage and blockage are the two failure modes for a PCV system. Either mode will cause crankcase pressure to build-up, though the effects of a blocked PCV are generally more dramatic. Increased case pressure will result in oil entering the combustion chamber.

1. The PCV chamber is vented to the air filter through a molded rubber hose. The rubber hose directs crankcase fumes to a covered duct within the air filter housing. See Figure 2.3.



Figure 2.3

2. When functioning properly, the PCV valve (Positive Crankcase Ventilation) works with the inherent pumping action of the piston in the bore to expel pressure from the crankcase. See Figure 2.4.



Figure 2.4

- Normally, small engines run with slightly negative case pressure.
- This case pressure can be measured using a slack-tube water manometer, or an electronic version of the same tool.
- Less than (between zero and -1") (-2.54cm) of water is a typical reading.

NOTE: An adaptor can easily be made from an old or extra dipstick. See Figure 2.5.



Figure 2.5

Chapter 2: Basic Troubleshooting

3. An engine that fails to purge extra case pressure in a controlled manner will build case pressure. The pressure will find it's own way out of the engine in undesirable ways.
 - Oil will be forced by the rings and valve guides, being burnt in the combustion chamber.
 - The cause of this oil burning can be mistaken for a worn-out engine, if proper diagnosis (compression, leak-down, and case pressure) is not performed.
4. Experimentation by MTD's Training and Education Department has revealed the following characteristics of MTD engines:
 - A leaky PCV system will not build-up substantial case pressure.
 - A leaky PCV system will allow the engine to ingest contaminants through the system, accelerating engine wear.
 - A blocked PCV system will allow crankcase pressure to build very rapidly. Noticeable oil fumes will be evident in the exhaust within several minutes of normal operation.
5. The PCV chamber is accessible by removing the flywheel, as described in the IGNITION SYSTEM chapter of this manual. See Figure 2.6.

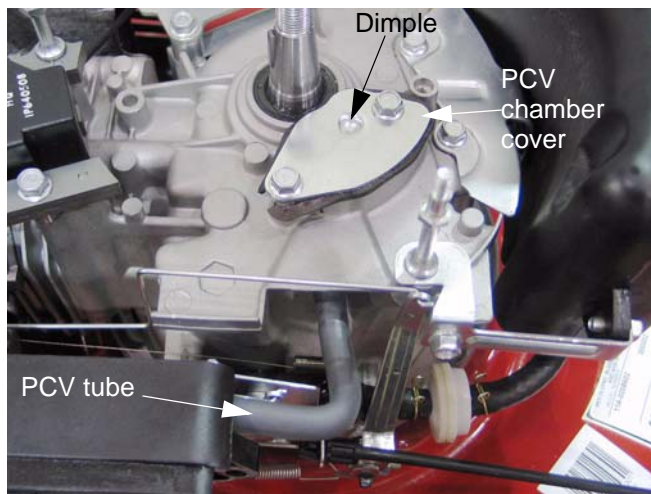

Figure 2.6

6. Remove the two screws that hold the PCV chamber cover to the engine block using a 10mm wrench.

7. The cover and gasket can be separated from the chamber. See Figure 2.7.

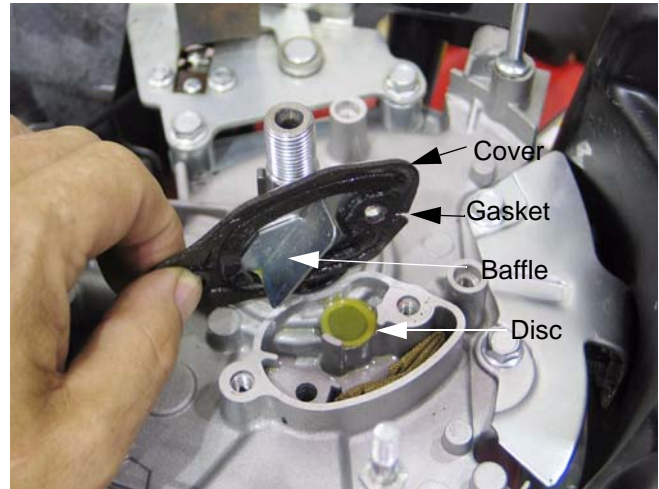

Figure 2.7

NOTE: The dimple in the cover helps locate the fiber disc over the port that leads into the crankcase.

NOTE: the baffle in the cover helps separate the oil from the air in the chamber. It is desirable to allow the air out, but important to keep as much oil as possible in the engine.

8. The disc acts as a check valve: pressure pulses force it off of the port, but it falls back over the port when the pressure drops.
9. The folded wire mesh in the chamber also helps separate the oil from the air. See Figure 2.8.

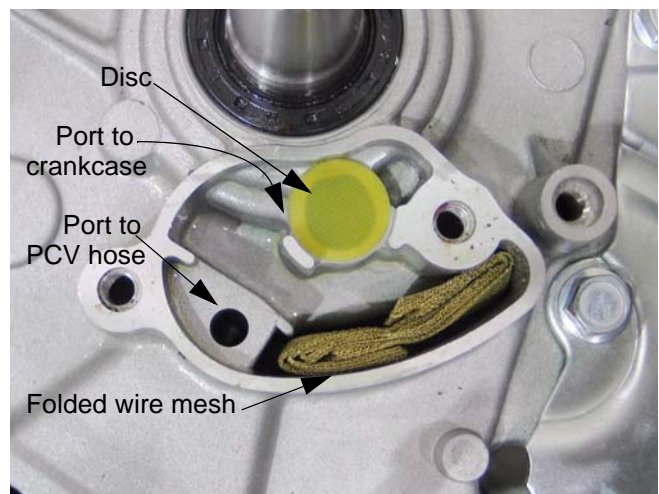

Figure 2.8

Chapter 2: Basic Troubleshooting

10. The port to the PCV hose is near the top of the chamber. The oil tends to settle out of suspension, leaving mostly air to exit the chamber through the PCV hose.
11. The screen accumulates droplets of oil, which eventually drip down to the bottom of the chamber. Beneath the screen is a drain-back port, leading to the crankcase. the size of the port is small enough that significant pressure does not flow through it. See Figure 2.9.

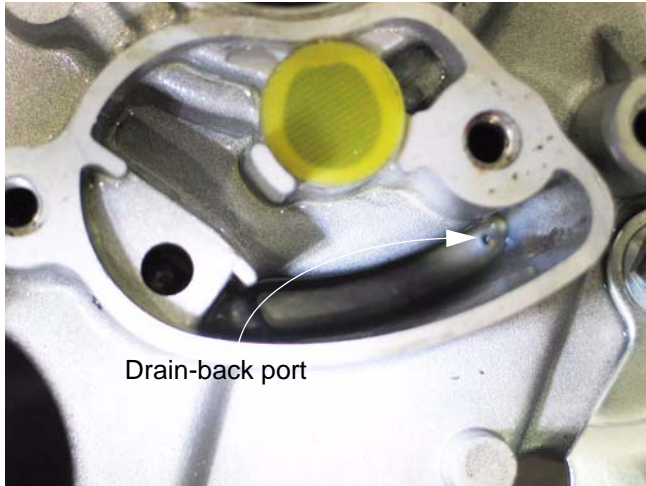

Figure 2.9

12. With the cover re-installed and torqued to 27-35 in-lbs. (3-4 Nm), vigorous pumping with a hand pump vacuum / pressure tester will result in a slight build-up of pressure within the chamber. See Figure 2.10.



Figure 2.10

- This 2-3 PSI (.14-.20 Bar) build-up will dissipate through the drain-back port over the course of 5-10 seconds.
- No vacuum should accumulate in the chamber unless the drain-back port is blocked and the disc is not moving from over the crankcase port.

Chapter 2: Basic Troubleshooting

CHAPTER 3: AIR INTAKE AND FILTER

Air filters

The main function of the air filter is to trap air borne particles before they reach the carburetor that can cause catastrophic internal engine damage.

MTD vertical shaft engines use two different air filters. The first is a rectangular paper pleated filter with a foam pre-filter. The second is an oval foam filter. See Figure 3.1.

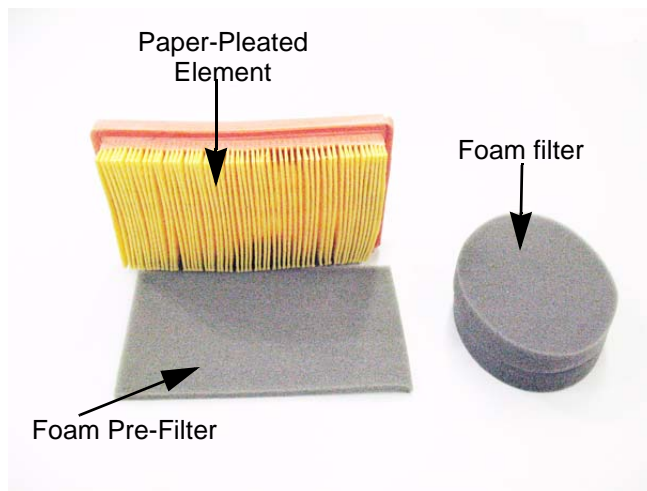

Figure 3.1

- Air filters used on the MTD engine are designed to prevent particles larger than 3-5 micron from passing through into the engine.
- The filter should be checked on a regular basis possibly several times in a season.

NOTE: Never use compressed air on a paper air filter. Compressed air will remove the tiny fibers that are used to catch the dirt in the air. Without these fibers the filter is useless.

NOTE: Refer to Chapter 1: Introduction for the maintenance interval and cleaning instructions for the air filter.

Paper air filter

1. To access the air filter, remove the thumb screw that holds the air filter cover closed.
2. Swing open the filter cover. See Figure 3.2.



Figure 3.2

3. Remove the air filter and the pre-cleaner.
4. Install the filters by following the above steps in reverse order.

Air filter housing

To remove the air filter housing:

1. Remove the air filter by following the steps described above.

Chapter 3: Air Intake and filter

2. Remove the screw that holds the air filter housing to the control bracket. See Figure 3.3.

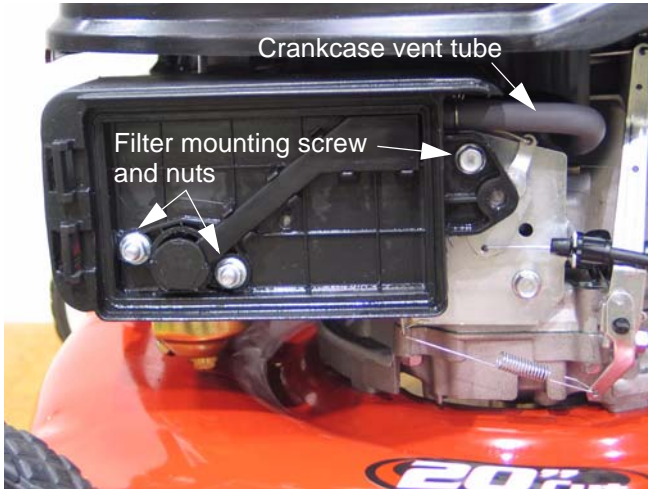

Figure 3.3

3. Remove the two nuts that hold the air filter body to the carburetor mounting studs. See Figure 3.3.
4. Disconnect the crankcase vent tube.
5. Lift away the filter housing.

NOTE: Behind the filter housing is a steel plate with formed rubber gaskets vulcanized to each surface. See Figure 3.4.

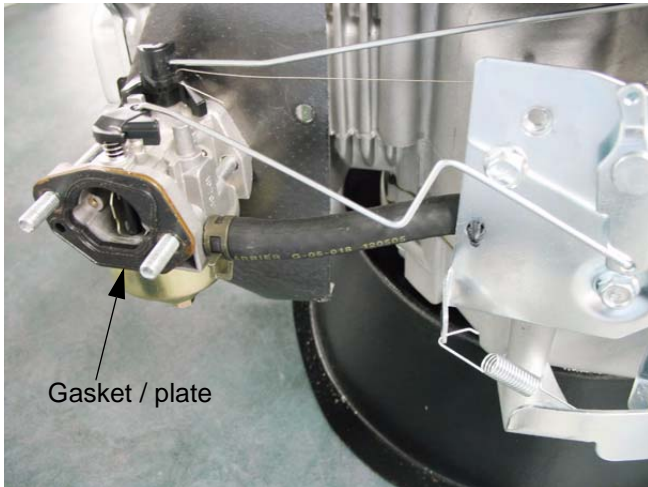

Figure 3.4

NOTE: Mark or note the orientation of the plate. Notches in the plate allow air to reach emulsion ports: one for the main jet and one for the pilot jet. Channels in the rubber provide air passage to the choke-side bowl vent.

Foam air filter

1. Press in the tab on the air filter cover. See Figure 3.5.



Figure 3.5

2. Swing open the filter cover. See Figure 3.6.



Figure 3.6

3. Remove the air filter.
4. Install by following the above steps in reverse order.

Chapter 3: Air Intake and filter

Air filter housing

To remove the air filter housing:

1. Remove the air filter by following the steps described above.
2. Remove the screw that holds the air filter housing to the control bracket. See Figure 3.7.



Figure 3.7

3. Remove the two nuts that hold the air filter body to the carburetor mounting studs. See Figure 3.7.
4. Disconnect the crankcase vent tube. See Figure 3.8.

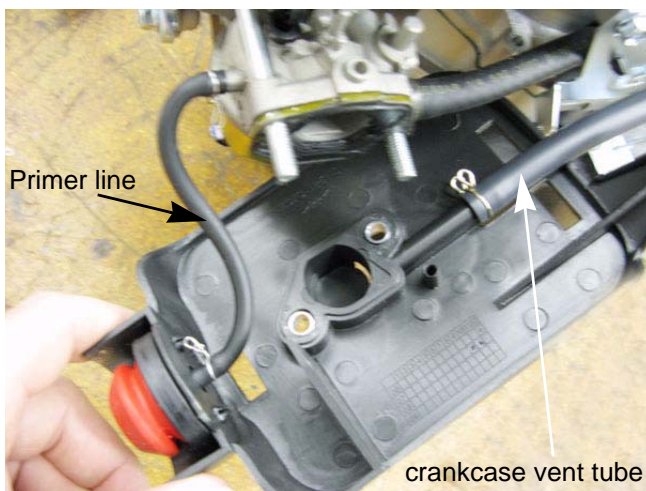

Figure 3.8

5. Disconnect the primer line. See Figure 3.8.
6. Lift away the filter housing.
7. The primer can be removed from the air filter housing by squeezing together the two sets of barbs while pushing the primer out of the housing. See Figure 3.9.

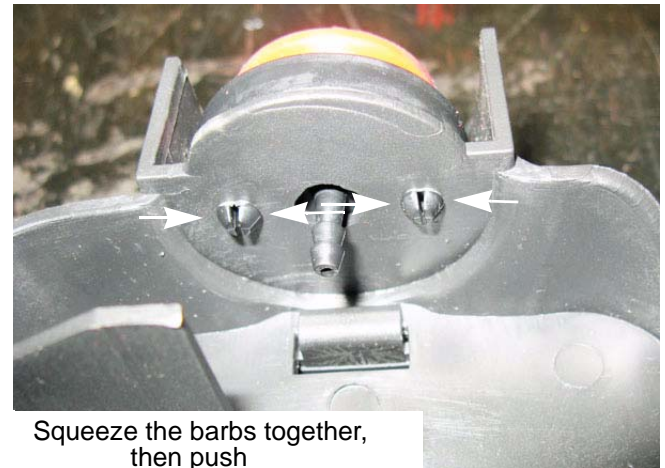

Figure 3.9

NOTE: Behind the filter housing is a steel plate with formed rubber gaskets vulcanized to each surface. See Figure 3.10.

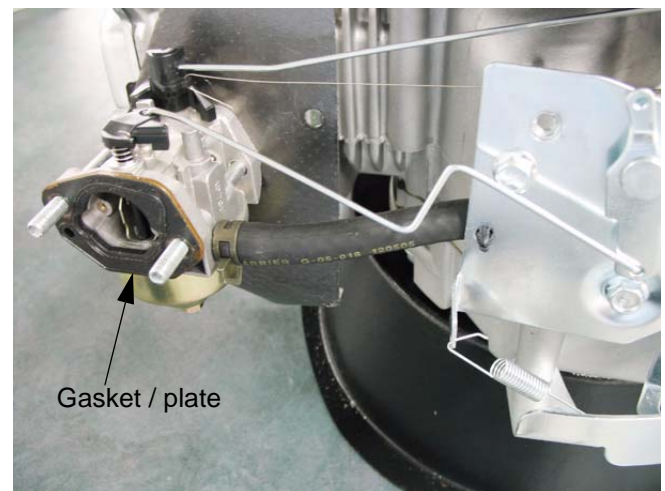

Figure 3.10

NOTE: Mark or note the orientation of the plate. Notches in the plate allow air to reach emulsion ports: one for the main jet and one for the pilot jet. Channels in the rubber provide air passage to the choke-side bowl vent.

Chapter 3: Air Intake and filter

Carburetor Insulator

CAUTION: When working around the fuel system, do not bring any sources of heat, spark, or open flame near the work area.

1. Remove the air filter housing by following the previously described steps.
NOTE: Drain the fuel tank or clamp the fuel line before starting work to prevent spillage.
NOTE: Dispose of drained fuel in a safe and responsible manner.
2. Remove the carburetor.
 - 2a. Disconnect the fuel line.
 - 2b. Double-nut the studs for removal, with a washer between the serrated faces of the nuts. See Figure 3.11.

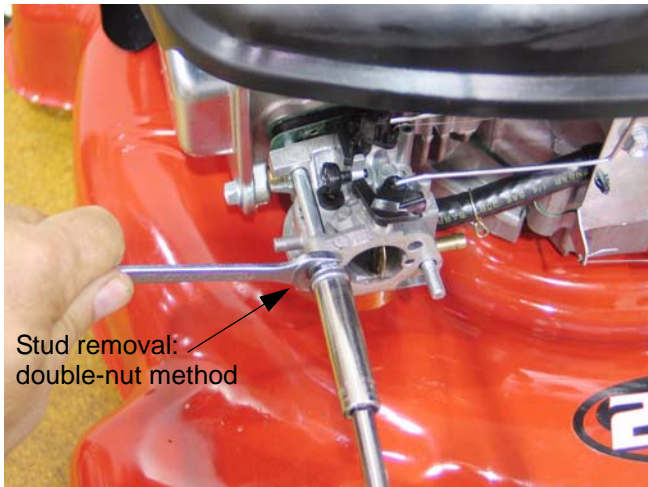

Figure 3.11

- 2c. After the second stud is removed, the carburetor can be maneuvered to disconnect the linkages. See Figure 3.12.

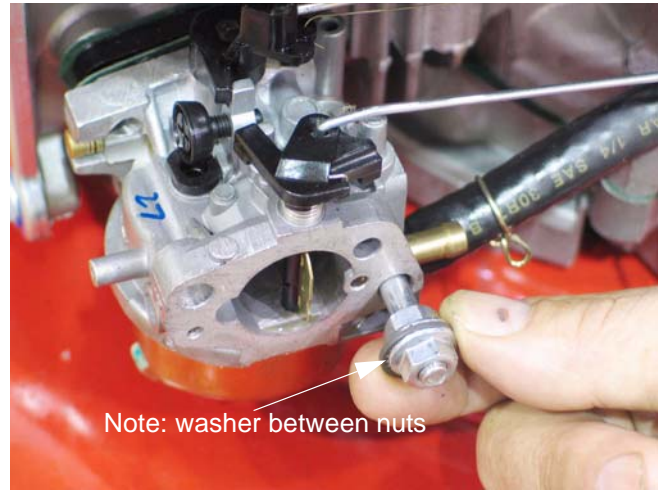

Figure 3.12

- 2d. Rotate the throttle arm until it meets the idle speed screw, then pivot the carburetor slightly to disengage the 90 degree bend at the end of the governor rod. See Figure 3.13.

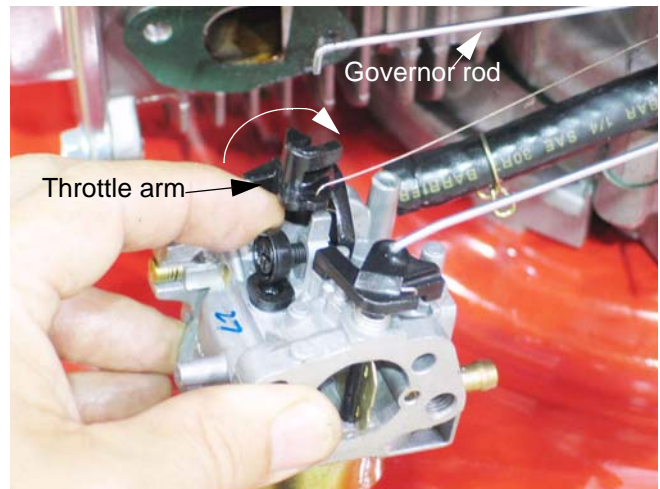

Figure 3.13

Chapter 3: Air Intake and filter

- 2e. Pivot the carburetor to disengage the Z-fitting on the end of the choke rod.
See Figure 3.14.

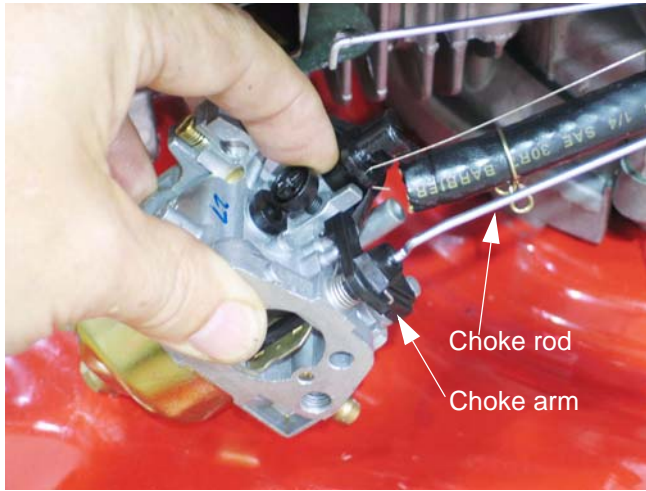

Figure 3.14

- 2f. Unhook the stabilizer spring that takes-up the play between the governor arm, the governor rod, and the throttle arm on the carburetor.

NOTE: The carburetors are not inter-changeable from one engine model to another. To help prevent carburetor mix-ups, the engine model number is stamped on the carburetor by the fuel nipple. See Figure 3.15.

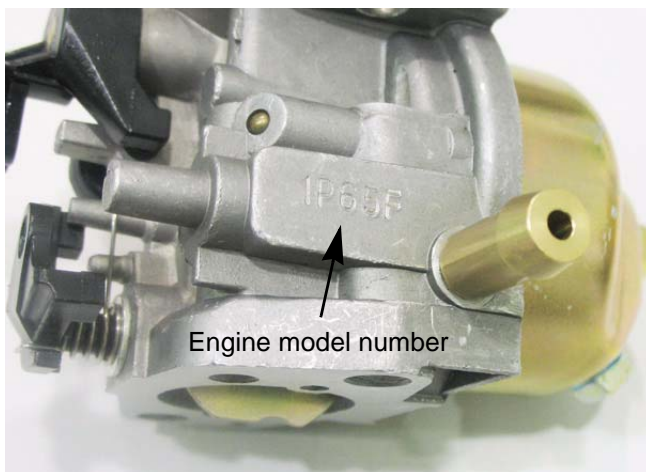

Figure 3.15

3. The insulator is sandwiched between two gaskets which are located between the carburetor and the cylinder head. See Figure 3.16.

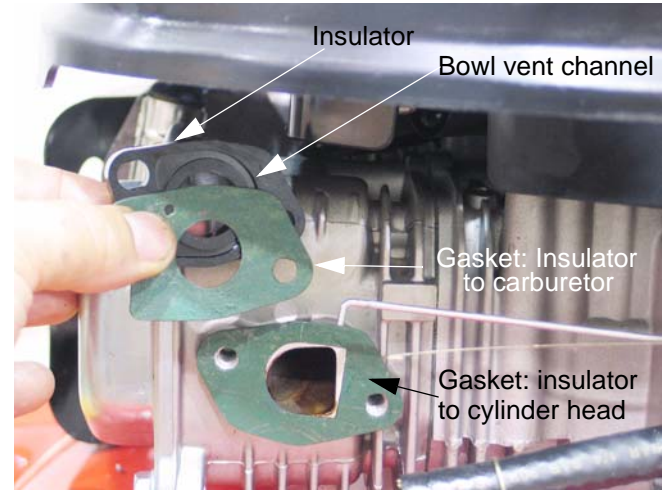

Figure 3.16

NOTE: The gaskets are different, and there is an orientation to the insulator.

NOTE: On current production the insulator to cylinder head gasket has been replaced with a graphite gasket/heat shield. See Figure 3.17.



Figure 3.17

Chapter 3: Air Intake and filter

- The gasket with the “D” shaped opening goes between the insulator and the cylinder head, matching the shape of the gasket to the shape of the intake port.
 - The bowl vent channel in the insulator faces the carburetor, with the exit toward the bottom.
 - There is a small hole in the insulator to carburetor gasket. The hole should be aligned to allow passage of air through the bowl vent channel to the throttle side bowl vent in the carburetor body.
4. Install the insulator by following the above steps in reverse order.

NOTE: Tighten the carburetor mounting nuts to a torque of 88.5 in-lbs (10 Nm).

5. Test run the engine before returning to service.

CHAPTER 4: THE FUEL SYSTEM AND GOVERNOR

The function of the fuel system is to store, mix the fuel with air and deliver it to the combustion chamber. The fuel system consists of the following components:

- Fuel tank
- Fuel lines
- Fuel filter
- Carburetor

NOTE: When working on the fuel systems, look at the whole system. A problem will rarely be isolated to one component.

Inspecting the fuel:

NOTE: Fuel is the maintenance item most often overlooked by consumers. A lot of fuel systems problems are caused by bad gas or too much alcohol in it. When inspecting the fuel:

- Look for water.
- Look for dirt.
- Look for discoloration.
- Sniff carefully to see if it smells like varnish or kerosene.
- Save the fuel to show to customer.
- Look for oil in the fuel.
- Test the fuel for alcohol content if there is a reason to suspect it.

NOTE: Save a sample of the fuel collected to show the customer.

NOTE: Customers pouring engine oil into the fuel tank seems to be a growing problem.

Test fuel for alcohol:

Fuels currently on the market contain a wide array of additives. Some of these additives oxygenate the fuel. Oxygenated fuel reduces emissions, and is required in some parts of the United States. Fuel make-up varies seasonally and geographically. Ethanol is the primary additive used to oxygenate fuel.

Ethanol in fuel creates a lot of problems for gasoline engines. The biggest problem is that alcohol attracts and holds water. This corrodes the metal components of the fuel system, especially the carburetor. Alcohol also does not produce as much heat as gasoline when burnt. This results in less power for the engine.

A 10% ethanol (E10) mix is acceptable for MTD engines. Anything higher than that will result in performance issues.

NOTE: E20 and E85 fuels are not to be used in any MTD engines.

There are several alcohol test kit available commercially. See Figure 4.1.



Figure 4.1

Chapter 4: The Fuel System and Governor

Generally these kits involve mixing a measured amount of water and gas together and seeing where the boundary layer is. See Figure 4.2.



Figure 4.2

The test kit should come with a chart to compare the boundary layer height to alcohol percentage.

Fuel tank vent

The fuel tank vent performs the important task of allowing air into the fuel tank. As fuel is being used by the engine, the fuel level in the tank drops. The dropping fuel level then creates a vacuum in the tank. If the fuel tank could not suck air through the vent, the vacuum would prevent the fuel from getting to the carburetor.

The tank is vented through the cap. See Figure 4.3.

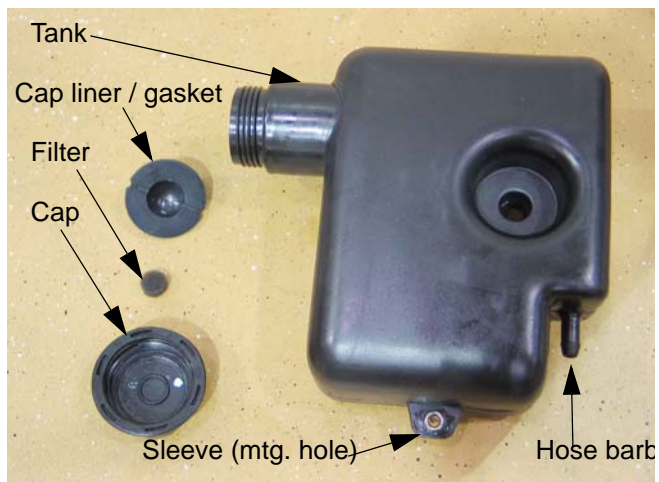

Figure 4.3

To test the cap vent

1. A hand-pumped vacuum / pressure tester may be connected to the fuel barb (after draining). See Figure 4.4.

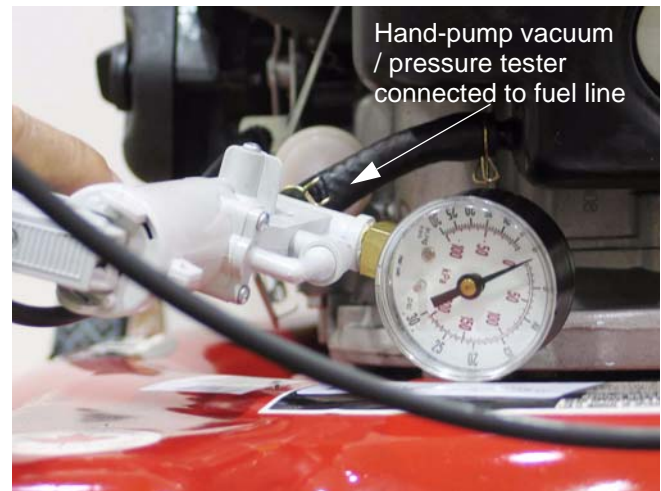

Figure 4.4

2. The tank should not hold any pressure nor any vacuum.
 - Replace the cap if either pressure or vacuum builds using the hand-pump tester.
 - A cap that maintains pressure will cause the engine to run rich as the fuel in the tank heats and expands, forcing it's way past the float valve in the carburetor.
 - A cap that maintains vacuum will cause the engine to run lean as the fuel is depleted and no air comes in to replace it.
 - The two conditions may both be present, but the symptoms vary with fuel, fuel level, and operating conditions.
 - Usually presents as a "Runs and quits" scenario.

Chapter 4: The Fuel System and Governor

The fuel filter:

The fuel filter is located in the fuel tank. It can be removed and cleaned with a can of carb cleaner or replaced. See Figure 4.5.



Figure 4.5

On some early production engines, an in-line filter was used. See Figure 4.6.

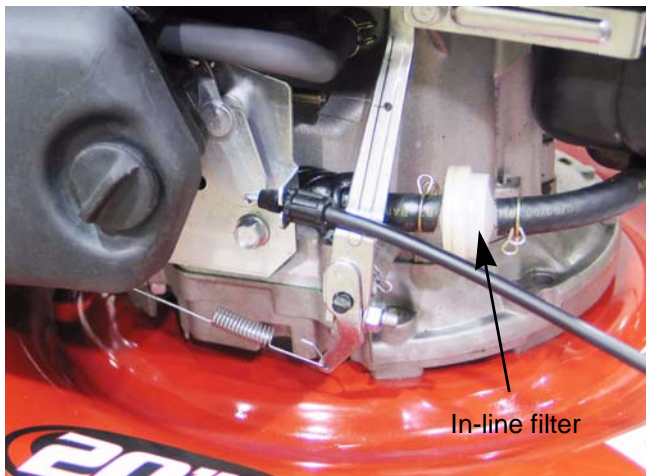

Figure 4.6

Inspect the fuel lines:

- Are they cracked?
- Are they clogged?
- Are they brittle?

NOTE: If the answer to any of the above is yes, replace the fuel lines. When replacing fuel lines, low permeable fuel line must be used in order to meet EPA and CARB standards.

CAUTION: When working around the fuel system, do not bring any sources of heat, spark, or open flame near the work area.

NOTE: The nipple has a sharp edge that will damage the inner lining of the fuel line. Replace the fuel line every time it is removed from the carburetor fuel nipple.

- Drain the fuel tank or clamp the fuel line before starting work to prevent spillage.
- Dispose of drained fuel in a safe and responsible manner.

The fuel tank:

The fuel tank is secured to a bracket on the back of the engine. See Figure 4.7.

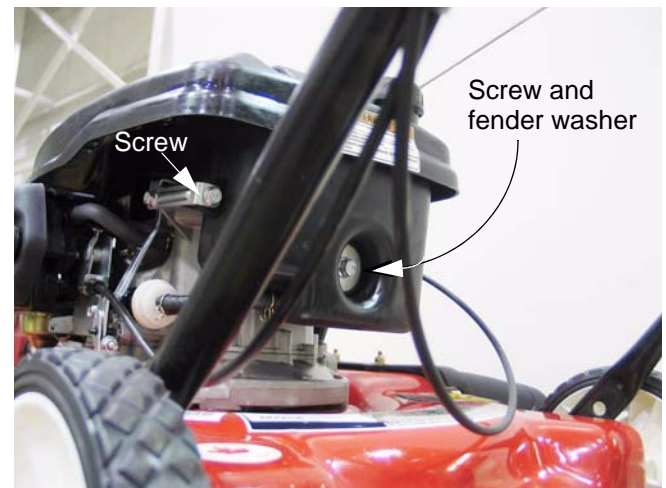

Figure 4.7

To remove the fuel tank:

1. Drain the tank.
2. Disconnect the fuel line from the tank.
3. Remove the fuel cap.
4. Unbolt, and remove the tank.
5. Install by following the above steps in reverse order.

Chapter 4: The Fuel System and Governor

Evaporative (EVAP) emissions system

Gasoline is made from the graduated distillation of crude oil. It consists of a multitude of individual hydrocarbons and has a boiling range of 86 - 410°F (30-210°C)¹. The large quantity of hydrocarbons and the low boiling range makes gasoline an ideal fuel for spark ignited, internal combustion engines. However, the hydrocarbons are not good for the environment. To reduce or eliminate the release of fuel vapors into the atmosphere, an evaporative (EVAP) emissions system is used. Starting with the 2008 season, an EVAP system has been offered in areas that require it. MTD has two systems that can be used. The first one is a charcoal canister system and the second (available starting in the 2009 model year) is redesigned EVAP fuel tank.

The charcoal canister system can be identified by the charcoal canister. See Figure 4.8.

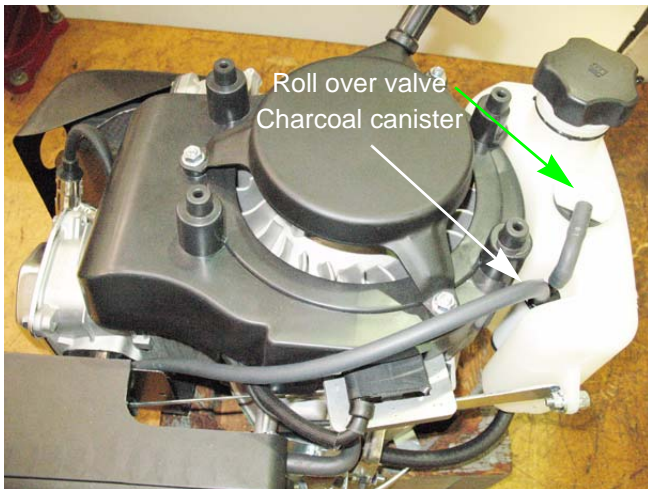

Figure 4.8

The charcoal canister system consists of:

- A charcoal canister
- The fuel tank and cap
- A roll over valve vent
- A carburetor insulator.
- Vacuum lines

This system operates as follows:

1. The gasoline evaporate and lets off vapors.
2. The vapors exit the fuel tank through the roll over valve vent.

NOTE: The fuel cap used with the charcoal canister system is not vented. If a vented cap is used, the EVAP system will not work. See Figure 4.9.

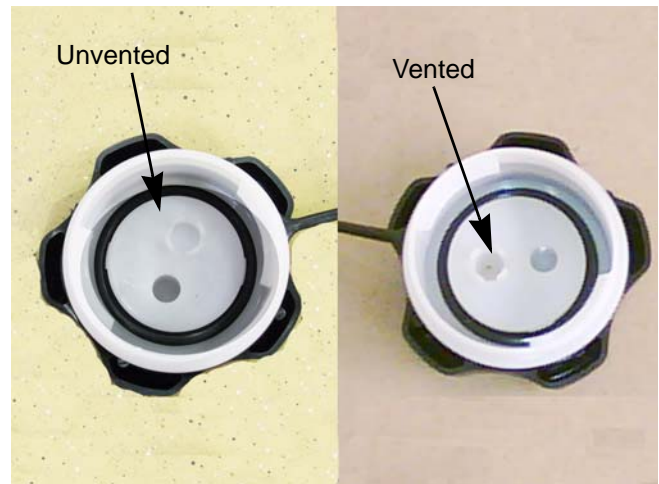

Figure 4.9

3. The vapors are routed through the charcoal canister. See Figure 4.10.

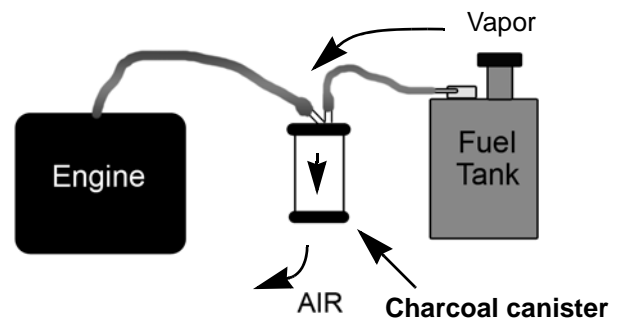

Figure 4.10

Chapter 4: The Fuel System and Governor

4. The activated charcoal inside the canister absorbs the hydrocarbons allowing the air to pass through and out to the atmosphere.
5. When the engine is running, the vacuum inside the carburetor insulator is used to draw the vapors out of the charcoal canister, temporarily enriching the fuel/air mixture, and is used in the combustion process. See Figure 4.11.

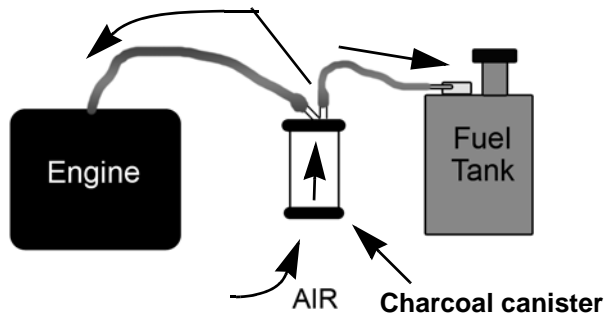

Figure 4.11

Troubleshooting

Table 1:

Symptom	Cause
Fuel leaking from the carburetor throat or vents	A blockage in the charcoal canister or between the canister and the tank.
Engine runs rich	<ul style="list-style-type: none"> • Raw gasoline in the charcoal canister. • A blockage in the line between the charcoal canister and the carburetor insulator plate.
Engine runs lean	<ul style="list-style-type: none"> • Wrong fuel cap installed. • Leak in the vacuum lines.
Gasoline vapor escaping from the engine	<ul style="list-style-type: none"> • The charcoal canister is saturated. • A blockage in the line between the charcoal canister and the carburetor insulator plate. • Wrong fuel cap installed. • Leak in the vacuum lines.

Chapter 4: The Fuel System and Governor

Charcoal canister fuel tank

To remove/replace the fuel tank:

1. Drain the tank.
2. Disconnect the fuel line from the tank.
3. Disconnect the vacuum line that runs from the charcoal canister to the carburetor insulator. See Figure 4.12.

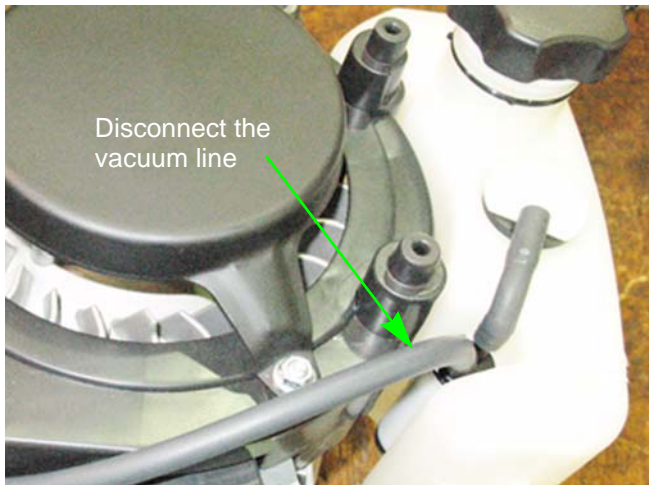

Figure 4.12

4. Remove the bottom screw using a 10mm wrench. See Figure 4.13.



Figure 4.13

5. Remove the top two screws and remove the tank. See Figure 4.14.

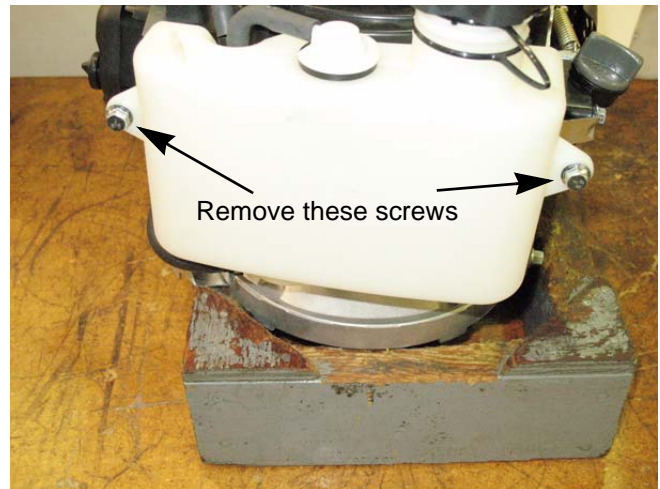

Figure 4.14

6. Install the tank by following the above steps in reverse order.
7. Test run the engine in a safe area before returning to service.

Chapter 4: The Fuel System and Governor

Roll over valve vent

To remove/replace the roll over valve:

1. Disconnect the vacuum line. See Figure 4.15.

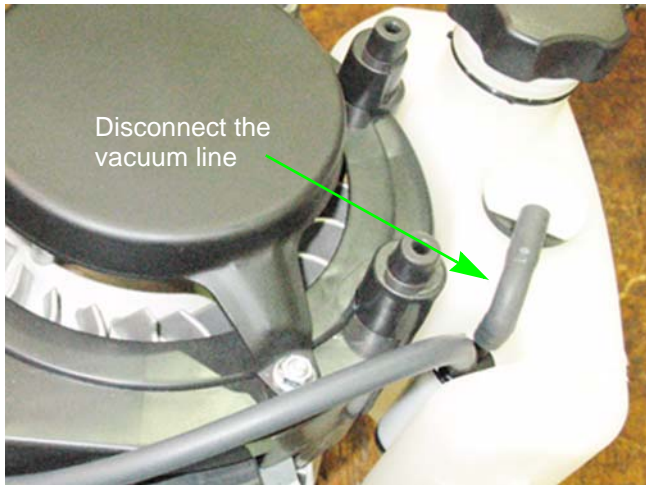

Figure 4.15

2. Gently pry the roll over valve out of the fuel tank. See Figure 4.16.

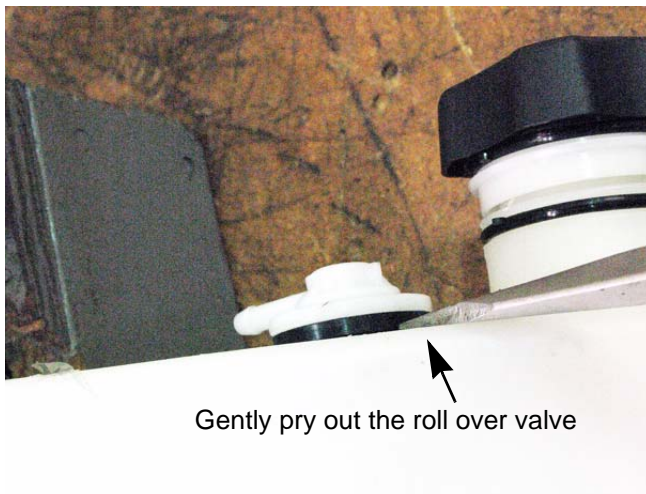

Figure 4.16

3. Inspect the rubber grommet, replace if damaged.

4. With the grommet on the roll over valve, install the roll over valve by pressing it into the opening in the tank. See Figure 4.17.

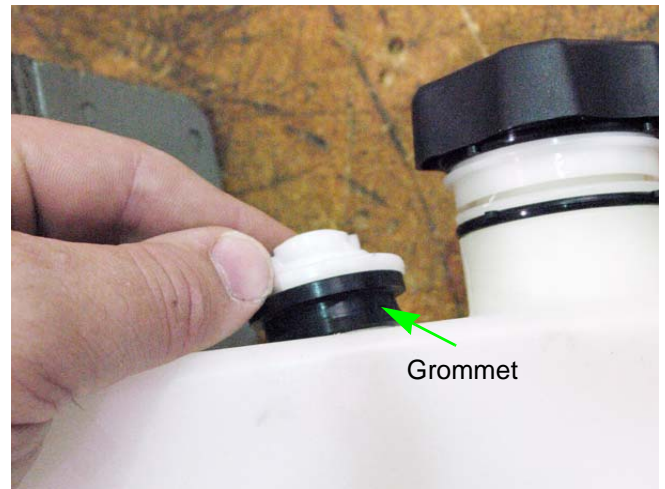

Figure 4.17

5. Install the vacuum line.
6. Test run the engine in a safe area before returning to service.

Testing the roll over valve

The roll over valve vent has two functions. The first function is to vent the tank and the second function is to close off the vent if the tank is inverted.

Test the roll over valve by:

1. Remove the roll over valve by following the steps described above.
2. Connect a vacuum pump to the roll over valve.
3. Hold the roll over valve in an inverted position.

Chapter 4: The Fuel System and Governor

4. Apply a vacuum to the roll over valve.
See Figure 4.18.

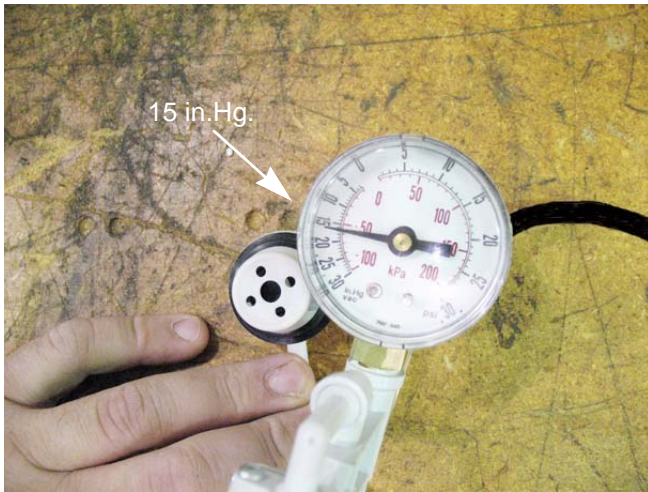

Figure 4.18

NOTE: The roll over valve should hold 15 in.Hg. for 15 seconds.

5. With the vacuum still applied, turn the roll over valve over. See Figure 4.19.

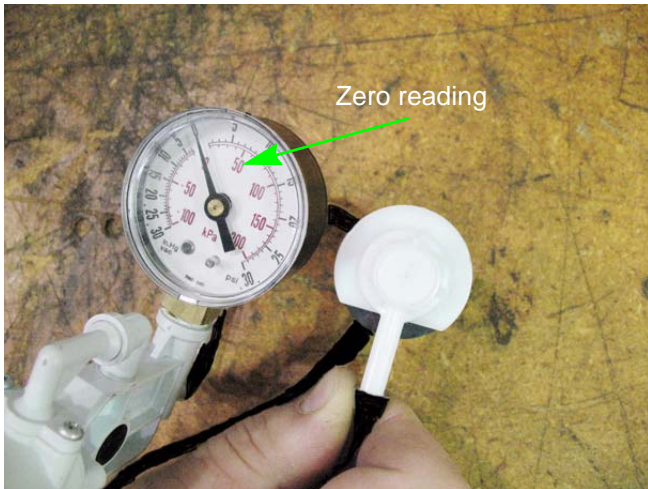

Figure 4.19

NOTE: The vacuum should be relieved.

6. If the results do not match what is listed above, replace the roll over valve.

Charcoal canister

To remove/replace the charcoal canister:

1. Remove the fuel tank by following the steps described in the Charcoal canister fuel tank section of this chapter.
2. Remove the vacuum line that runs from the roll over valve to the charcoal canister. See Figure 4.20.

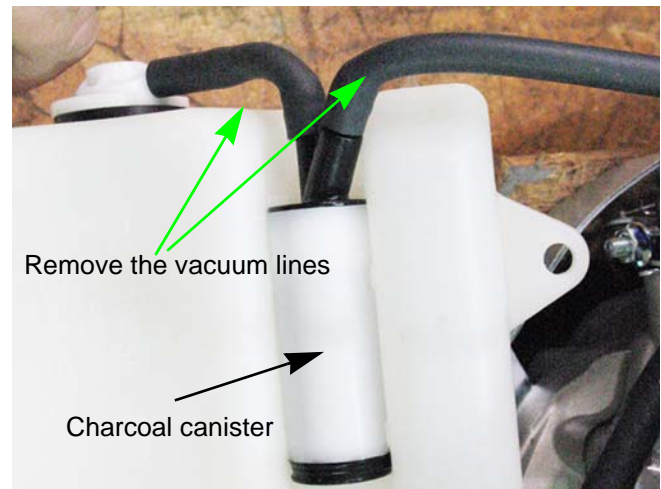

Figure 4.20

3. Unsnap the charcoal canister from the fuel tank.
4. Install the charcoal canister by following the above steps in reverse order.

Chapter 4: The Fuel System and Governor

EVAP fuel tank

Starting with the 2009 model year, an EVAP fuel tank will be used in place of the charcoal canister system to reduce the evaporative emissions.

The EVAP tank, like the charcoal canister tank is made out of a material that does not allow hydrocarbons to seep through it. The differences between the two tanks are that the EVAP tank has a channel machined into the insert to allow the tank to vent through the cap and it does not have a hole for the roll over valve.

See Figure 4.21.

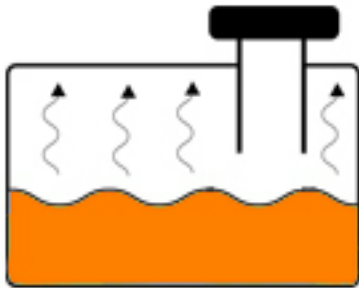

Figure 4.21

The trapped vapors are then allowed to escape through a tiny passage in the filler neck. The passage limits how fast the vapor can reach the vent in the fuel cap.

NOTE: A vented gas cap must be used with the EVAP fuel tank. See Figure 4.22.

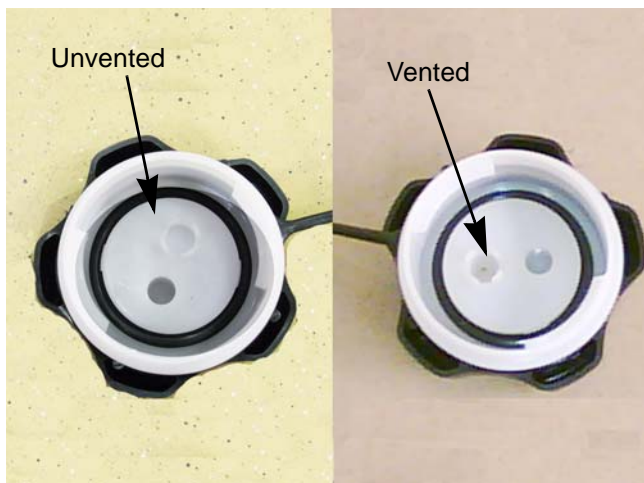

Figure 4.22

To remove/replace the fuel tank:

1. Drain the tank.
2. Disconnect the fuel line from the tank.
3. Remove the bottom screw using a 10mm wrench. See Figure 4.23.



Figure 4.23

4. Remove the top two screws and remove the tank. See Figure 4.24.

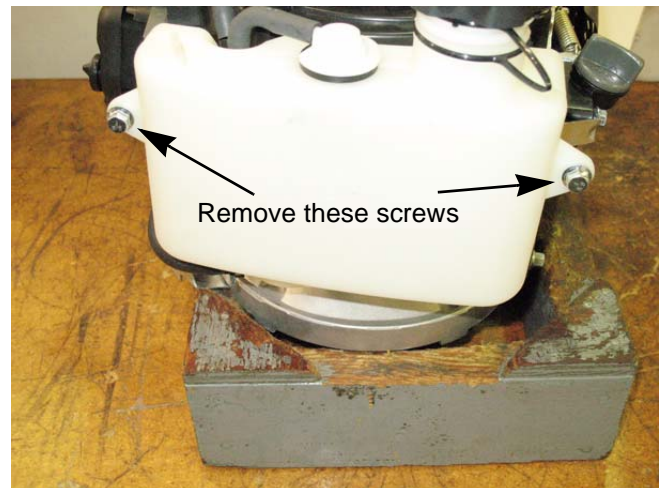

Figure 4.24

5. Install the tank by following the above steps in reverse order.
6. Test run the engine in a safe area before returning to service.

Chapter 4: The Fuel System and Governor

Manual Choke

If the engine is equipped with a manual choke, the choke must be closed to start the engine and opened when the engine starts. This can be a source of starting issues with customers who are not familiar with manual chokes.

The manual choke is operated by a pull knob at the carburetor or on the handle bar, depending on the application. If the choke plate fails to close fully when the knob is pulled, the mower will be difficult or impossible to start when cold.

NOTE: The rod connecting the choke lever to the choke arm on the carburetor can be bent slightly to facilitate adjustment. See Figure 4.25.

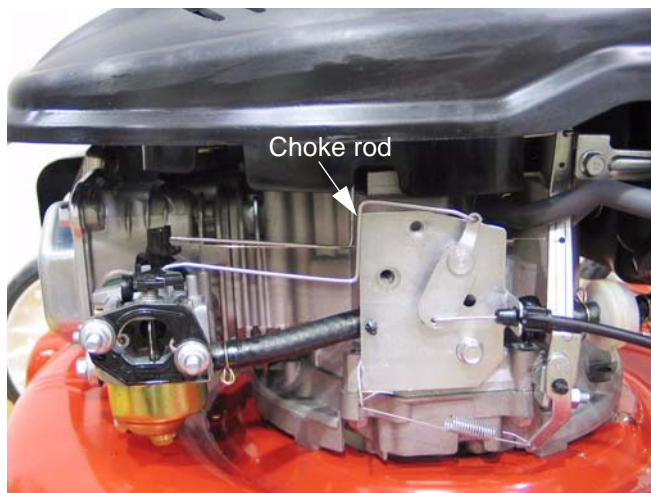

Figure 4.25

Autochoke

The MTD engine uses a simple autochoke system that is similar to the old style air vane governors. When the engine is at rest a spring holds the choke in the closed position. See Figure 4.26.

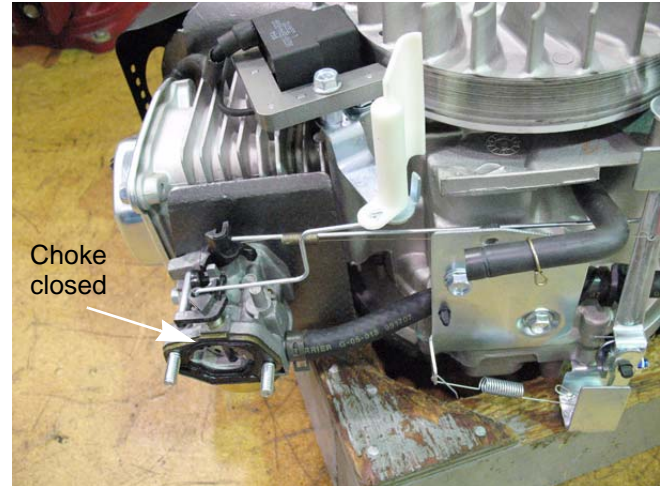

Figure 4.26

When the engine starts, the air flow from the flywheel fan pushes on an air vane. The air vane in turn moves the choke lever, opening the choke. See Figure 4.27.

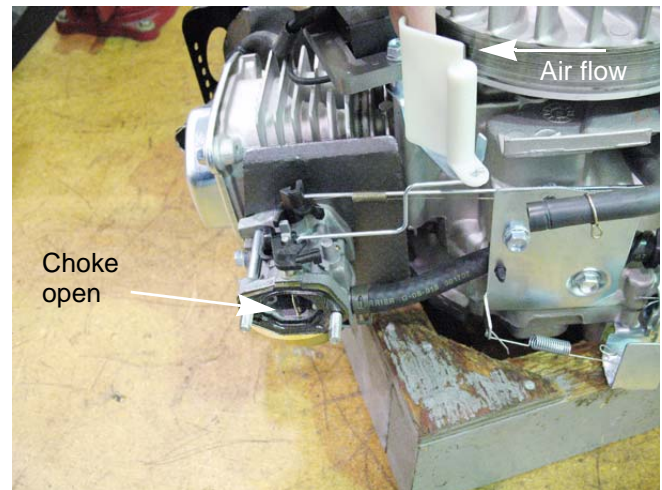

Figure 4.27

Chapter 4: The Fuel System and Governor

1P61/1P65

To remove/replace the air vane:

NOTE: The choke linkage can be slightly bent to make adjustments if the choke is not opening or closing fully.

1. Remove the ignition module by following the steps described in Chapter 7: Ignition System.
2. Loosen the screw that secures the air vane bracket to the cylinder block using a 10mm wrench. See Figure 4.28.

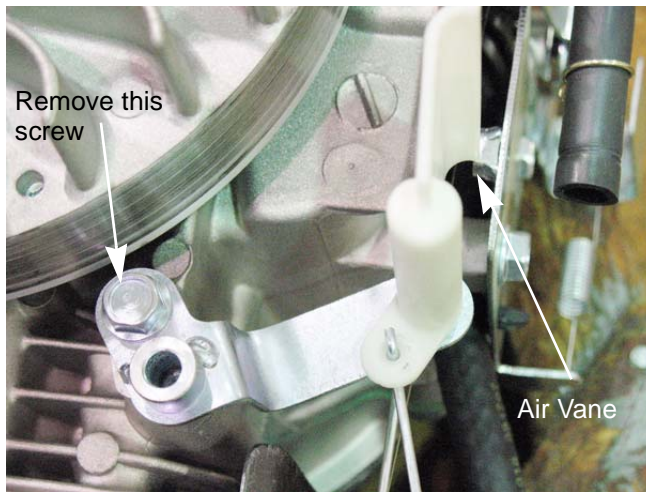

Figure 4.28

3. Slide the air vane off of the bracket. See Figure 4.29.

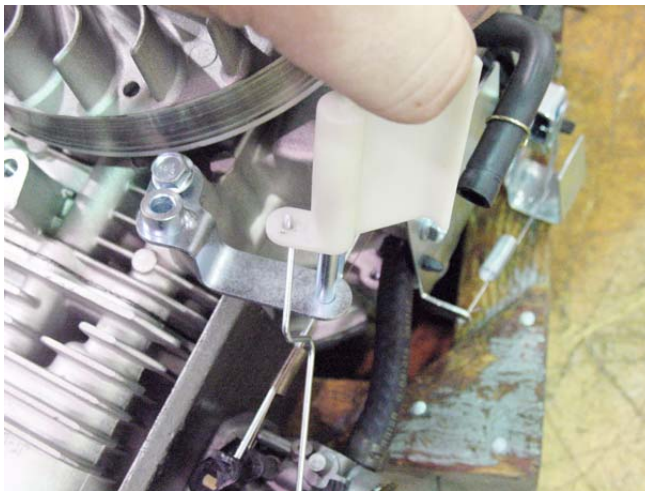

Figure 4.29

4. Unhook the choke linkage.
5. Install by following the above steps in reverse order.

1P70

The 1P70 autochoke uses an air door that functions the same way as the air vane described earlier.

NOTE: There is no choke linkage in this system, therefore there is no way to make adjustments for choke travel.

To remove/replace the air door:

1. Remove the starter and blower housing by following the steps described in Chapter 6: Starters.

NOTE: The air door is mounted to the underside of the blower housing. See Figure 4.30.



Figure 4.30

2. Gently pry open the retaining tabs. See Figure 4.31.



Figure 4.31

Chapter 4: The Fuel System and Governor

- Slide the air door rod out of the blower housing. See Figure 4.32.

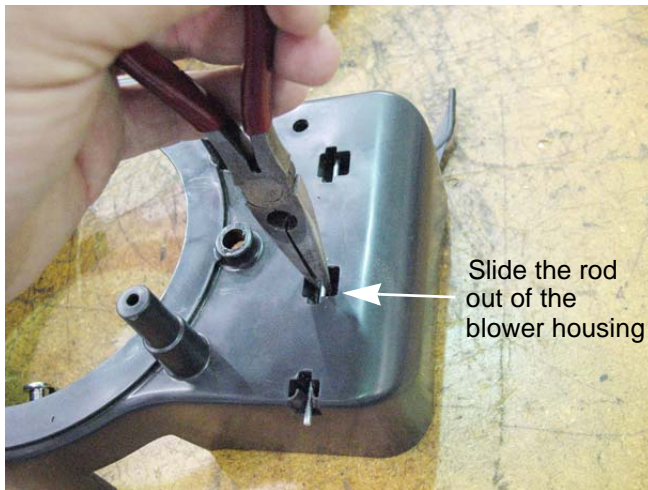

Figure 4.32

NOTE: The air door will fall off when the rod is removed.

- To install the air door, turn the blower housing upside down.
- Hold the air door in place while sliding in the rod.

NOTE: Make sure the rod goes through all of the rod channels. See Figure 4.33.



Figure 4.33

Primer

Another way to enrich the fuel air mixture for start-up is the primer. The primer is a simple pump that pressurizes the float chamber, forcing fuel out the main nozzle. See Figure 4.34.

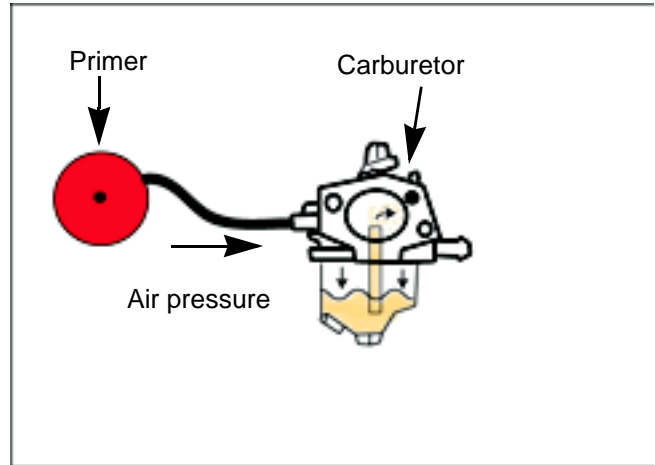

Figure 4.34

Carburetors that use a primer are easily identified by the lack of a choke plate and the addition of a primer port. See Figure 4.35.

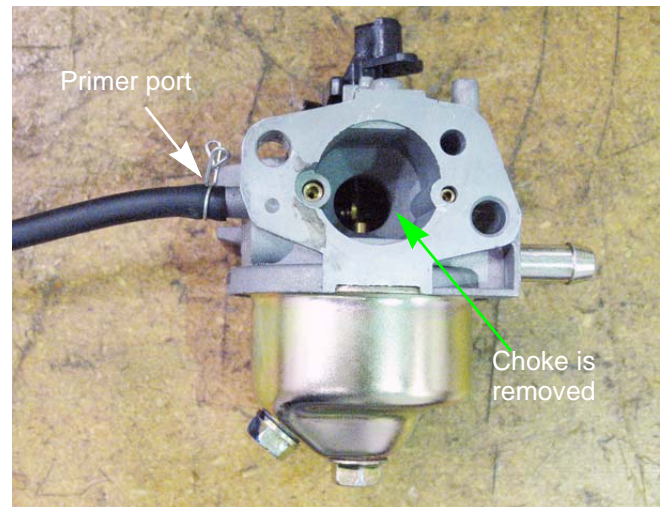

Figure 4.35

Chapter 4: The Fuel System and Governor

To remove/replace the primer:

1. Remove the air filter housing by following the steps described in Chapter 3: Air Intake And Filter.
2. Disconnect the primer line from the primer bulb. See Figure 4.36.

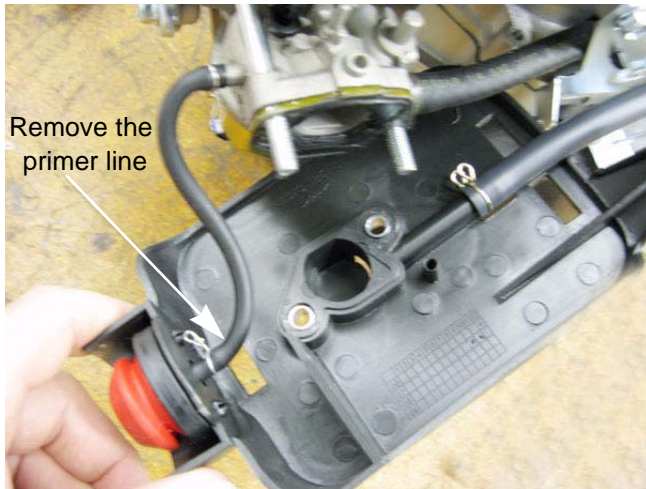

Figure 4.36

3. Squeeze the two sets of tabs together and push the primer out of the housing. See Figure 4.37.



Figure 4.37

4. Install the primer by following the above steps in reverse order.
5. Test run the engine before returning to service.

Carburetors

Troubleshooting the carburetor is a process of elimination. If everything else on the engine checks out, the carburetor is probably bad.

NOTE: It is important to perform a compression or leak down test before condemning a carburetor. An engine can have a borderline compression reading and not create enough of a vacuum to draw in a sufficient fuel/air charge.

NOTE: If the engine has borderline compression, a quick test to see if that is the problem is to remove the spark plug. Squirt a little bit of oil into the combustion chamber to seal the rings. Reinstall the spark plug. If the engine starts and runs ok, then that was the problem. If it does not start, move on to the carburetor.

Inspecting the carburetor:

1. Remove the float bowl and check for dirt and/or varnish.
2. Inspect the needle valve and needle valve seat for dirt and/or damage.
3. Inspect the gaskets and O-rings for damage.
4. Inspect the vents and orifices, verify that they are free of debris.

NOTE: If a little cleaning and new gaskets will fix the carburetor, do it. If the carburetor requires extensive cleaning it is better to replace the carburetor.

IMPORTANT: Never try to mechanically clean orifices. That will damage them and ruin the carburetor.

NOTE: The carburetors used on all vertical shaft engines are similar in design, but differ in calibration.

NOTE: The jet markings (if present) may be used for identification purposes, but the technician should not attempt to infer orifice sizes from the identification numbers.

NOTE: Installing the wrong main jet, or a carburetor with the wrong main jet will produce performance and emissions issues.

Chapter 4: The Fuel System and Governor

Disassembly and rebuilding the carburetor

1. Clamp off the fuel line to prevent fuel spillage and remove it.
2. Remove the carburetor by following the steps described in Chapter 3: Air Intake and Filter.

NOTE: There is a corresponding passage recessed into the mating surface where the throttle end of the carburetor housing meets the gasket. See Figure 4.38.

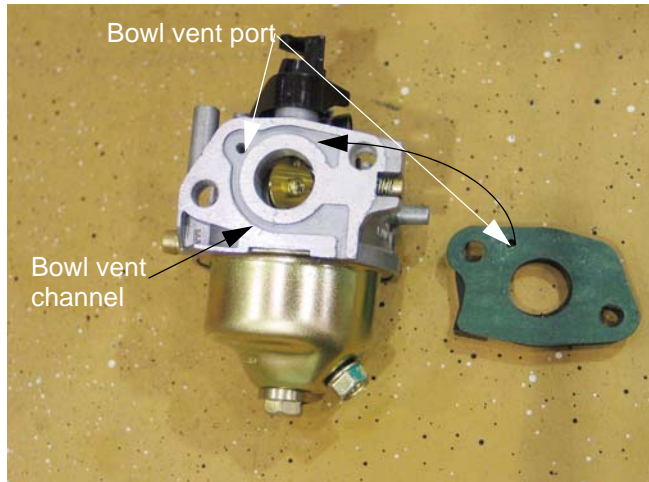

Figure 4.38

3. Remove the bowl bolt using a 10mm wrench. See Figure 4.39.

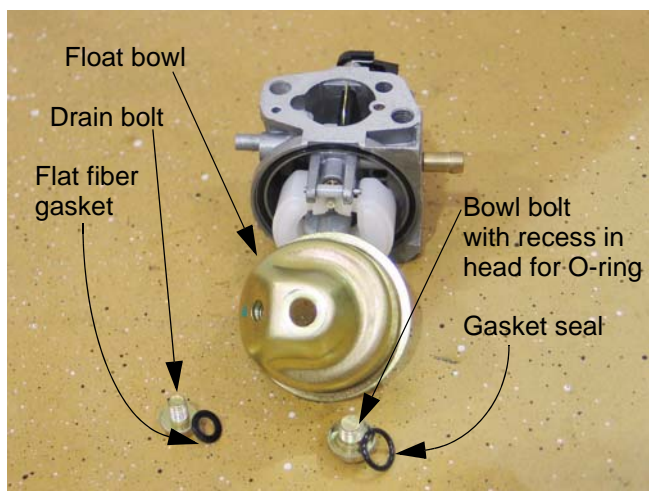

Figure 4.39

NOTE: From this point an assessment can be made about the viability of rebuilding the carburetor.

- If extensive corrosion is evident, replace the carburetor.

- If varnish build-up is too extensive to clean, replace the carburetor.
4. When inverted, the float should rest in a level position. See Figure 4.40.

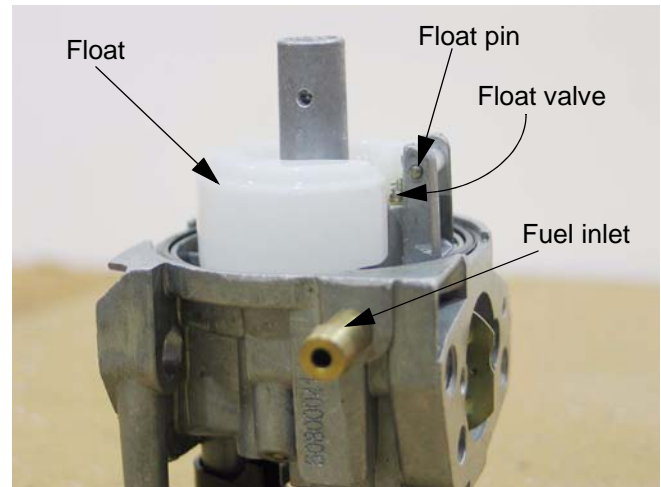

Figure 4.40

5. Remove the pin that the float hinges on to remove the float.

NOTE: The float is not adjustable. Spring tension against the float valve begins to build from the horizontal position, putting progressively more pressure between the tip of the valve and the seat. See Figure 4.41.

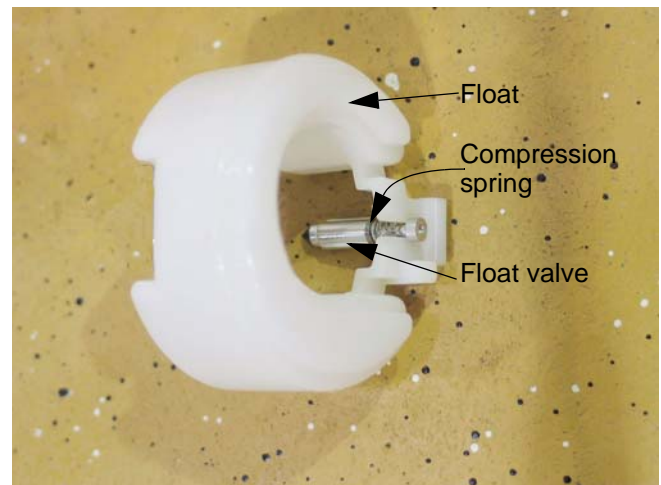

Figure 4.41

NOTE: Because the float valve is crucial to the functioning of the carburetor, and the viton tip of the valve is subject to wear, it is suggested that technicians replace the valve and spring any time the carburetor is disassembled for cleaning.

Chapter 4: The Fuel System and Governor

- A square cross-section gasket seals the bowl to the body of the carburetor.
6. Remove the main jet by using a narrow-shank straight blade screwdriver. See Figure 4.42.

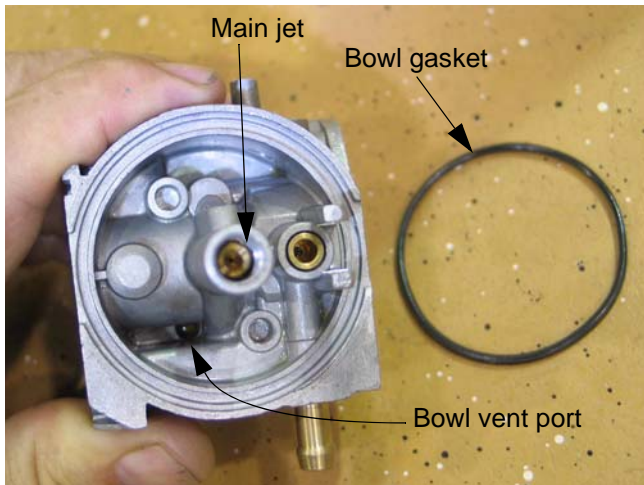

Figure 4.42

NOTE: A primer carburetor will have an additional port so that the air from the primer bulb can enter the float chamber. See Figure 4.43.

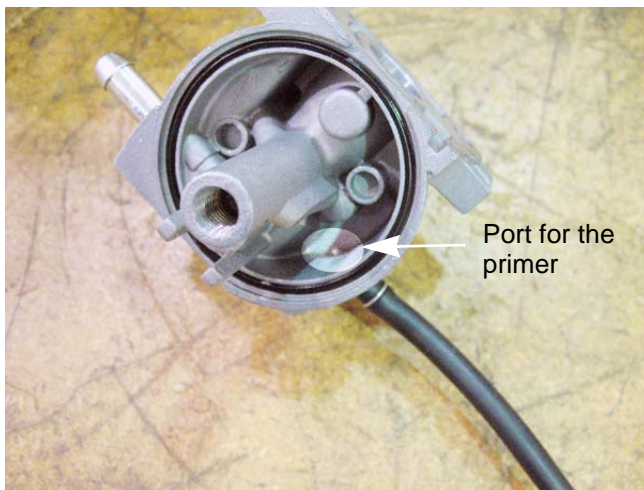

Figure 4.43

NOTE: Fuel enters the central column through a port about 1/2" (1cm) from the bottom, to help prevent the ingress of any residue in the bottom of the bowl.

NOTE: The orifice in the main jet meters fuel into the central column.

NOTE: Air from the main jet emulsion port enters the central column near the top, then gets bubbled through the emulsion tube into the metered fuel flow to promote atomization.

NOTE: The main jet secures the emulsion tube in the central column of the carburetor. See Figure 4.44.

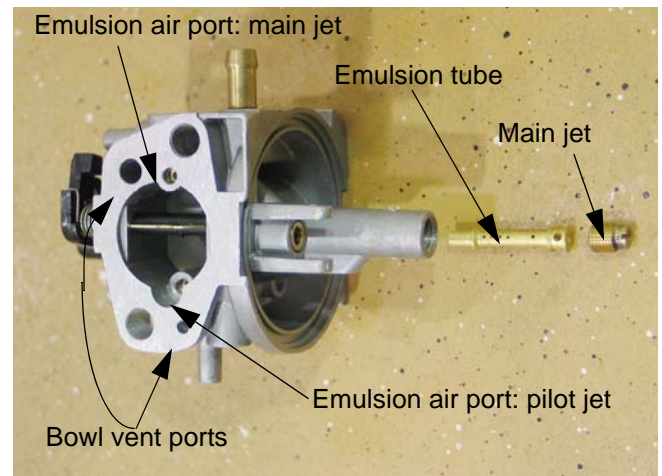

Figure 4.44

7. The throttle stop screw has a large pliable lip around the head of the screw. That lip secures a metering plug for the pilot and transition ports. Remove the screw to reach the plug. See Figure 4.45.

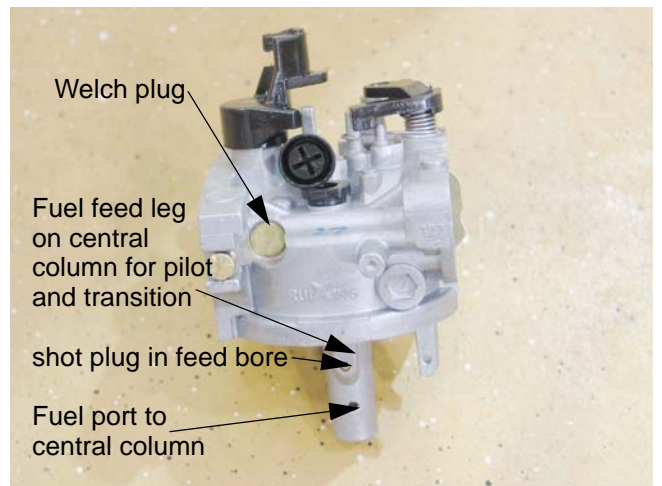

Figure 4.45

Chapter 4: The Fuel System and Governor

- Carefully pry out the metering plug using a small screwdriver. See Figure 4.46.



Figure 4.46

- Examine the metering plug: See Figure 4.47.

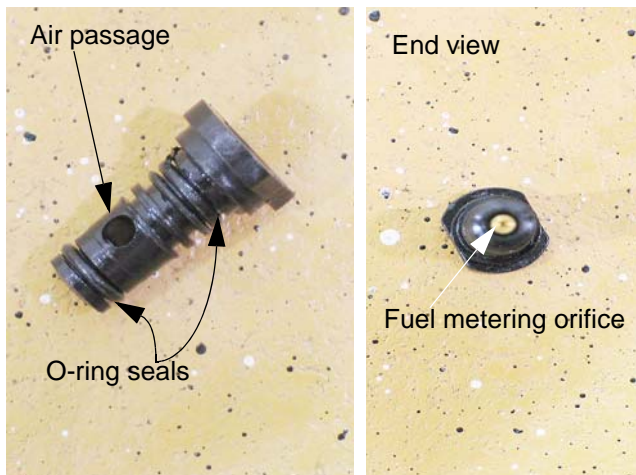

Figure 4.47

- Fuel, drawn from the central column via the long fuel feed leg, is metered by the brass orifice in the tip of the metering plug.
- Air, drawn from the emulsion air port, is metered by the size of the brass orifice at the entrance to the port.
- The fuel and air that feed the pilot and transition ports are mixed at the metering plug.
- The metering plug creates a small venturi. The pressure drop of the air passing through the metering plug draws the fuel into the passage to

the pilot and transition ports, in an emulsified mixture.

NOTE: In cut-away view, the passage by the metering port is visible. See Figure 4.48.



Figure 4.48

NOTE: The pilot screw regulates how much of this pre-mixed fuel/air emulsion is allowed to enter the throat of the carburetor, to atomize down-stream of the throttle plate. On early production carburetors the pilot screw is serviceable, but on current production units it is set at the factory with loctite to prevent movement from vibration. The screw head is removed to meet EPA and CARB requirements. See Figure 4.49.

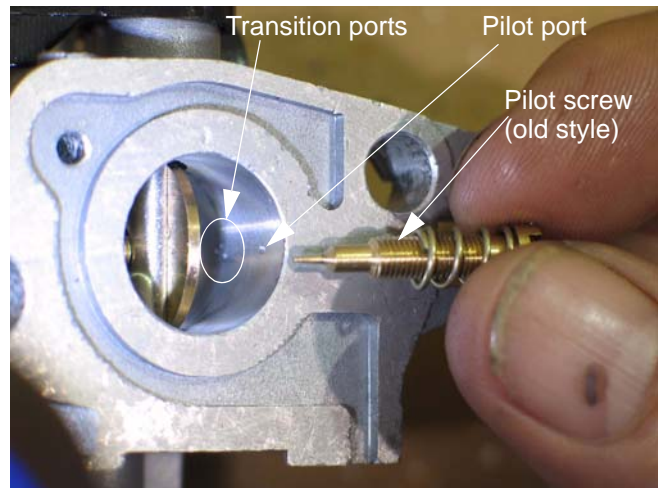

Figure 4.49

NOTE: The transition ports are fixed. They are drilled into the throat of the carburetor, downstream of the venturi. They lie behind the brass welch plug near the pilot screw.

Chapter 4: The Fuel System and Governor

10. Soak the Carburetor body in a suitable solvent until clean.
11. Rinse thoroughly.
12. Dry the carburetor body using compressed air.
13. Pre-installation adjustment:
 - 13a. Install the pilot screw gently turning it in all the way, then back it out 3/4 turn (270 degrees).
 - 13b. Tighten the idle speed screw until 1/8" (3 mm) of the screw is visible on the throttle arm side of the housing.
14. Reassembly the carburetor and install it by following steps 1-8 in reverse order.
15. Start engine and check the idle RPM using a tachometer.

NOTE: Idle speed: If applicable, is 1,800 RPM \pm 160 RPM, set using throttle stop screw. See Figure 4.50.

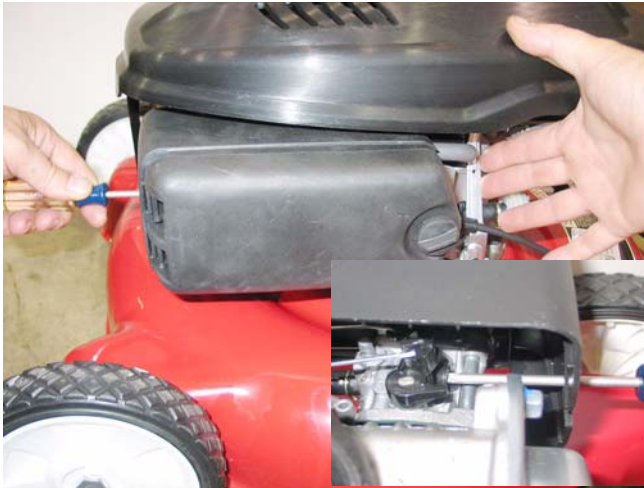

Figure 4.50

- For mower applications, the idle speed is not normally critical because the operator is not provided with a throttle control.

16. Check the top no load speed of the engine. See Figure 4.51.

NOTE: The top no load speed will vary depending on the application. The specification for it will be listed in the manual for each application.



Figure 4.51

17. Adjust the top no-load speed by slightly bending the bracket that the governor spring connects to. The bracket is visible under the air filter. See Figure 4.52.

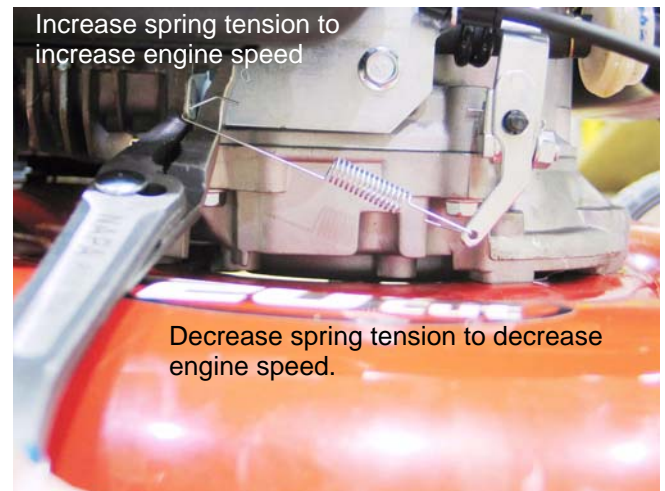

Figure 4.52

Chapter 4: The Fuel System and Governor

Governor

The engine speed is controlled by a balance between the force applied by a spring (pulling the throttle open) and a flyweight mechanism within the engine applying force to the governor arm (pushing the throttle closed). See Figure 4.53.

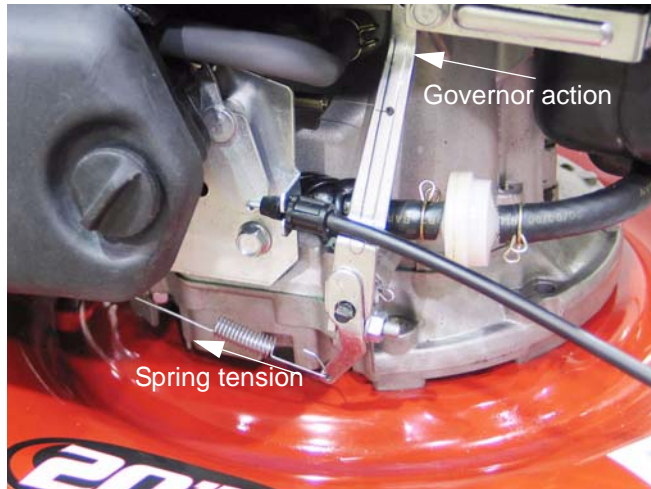

Figure 4.53

NOTE: While the mechanism is simple and robust, it is important to pay attention when working on parts near the governor. Binding caused by interference with mis-routed lines or cables may make the governor unresponsive.

NOTE: When a governed engine “hunts”, it is generally an indication of a lean fuel/air mixture, rather than a problem with the governor.

Governor arm

1. To remove the governor arm from the governor shaft:
 - 1a. Unhook the governor spring.
 - 1b. Unhook the governor linkage.
 - 1c. Loosen the nut and through bolt. See Figure 1.3.

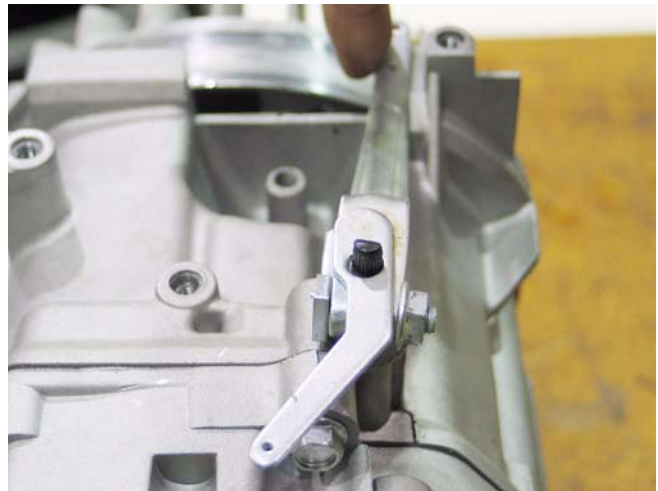

Figure 1.3

NOTE: The governor shaft is splined. If it is necessary to remove the governor arm, make an index mark to orient the shaft to the arm on installation and go to step 3.

- 1d. Carefully slide the Governor arm off of the governor shaft.
2. If the governor arm is being installed without benefit of index marks:
 - 2a. Rotate the governor shaft clockwise as far as it will go.
 - 2b. Position the top of the arm about 3/16" (.476cm) from the boss on the casting that provides a mounting point for the fuel tank bracket.

Chapter 4: The Fuel System and Governor

- Slide the arm onto the shaft. The flat on the top of the shaft should be roughly perpendicular to the shaft.
NOTE: There is a hairpin clip that keeps the governor shaft from sliding into the engine. It may be necessary to hold the shaft while sliding the arm on to prevent it from going into the engine.
- Tighten the nut on the clamp bolt to secure the arm.
- Attach the govern linkage and spring.
- Start the engine and check the top no load RPM using a tachometer.
- Adjust the governor to maintain top no-load speed as described in a previous section of this chapter.

Governor shaft

To remove or replace the governor shaft:

- Remove the engine from the unit.
- Remove the governor arm by following the previously described steps.
- Remove the sump by following the steps described in Chapter 10: Disassembly.
- Remove the hair pin clip from the governor shaft. See Figure 4.54.

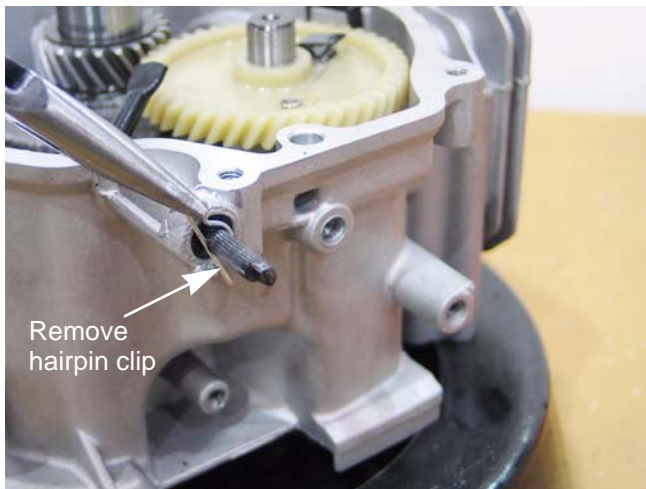

Figure 4.54

- Slide the governor arm out of the engine block from the inside of the engine. See Figure 4.55.



Figure 4.55

- Remove the governor shaft seal. See Figure 4.56.

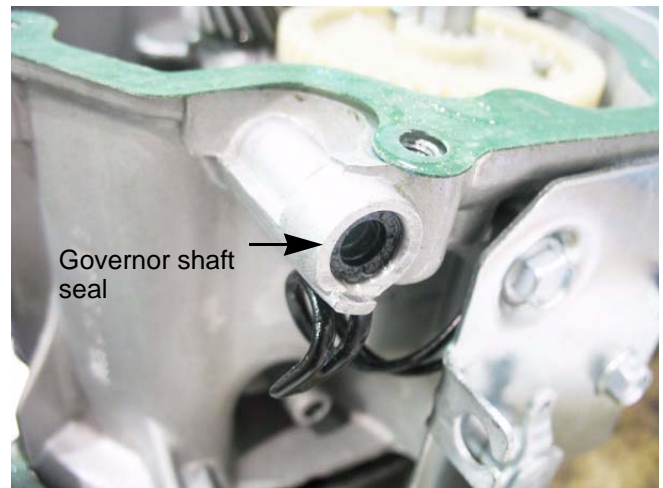

Figure 4.56

Chapter 4: The Fuel System and Governor

- Slide the governor shaft into the engine block from the inside of the engine.
- Carefully slide a new seal over the governor shaft and seat using a 1/4" deep well socket. See Figure 4.57.

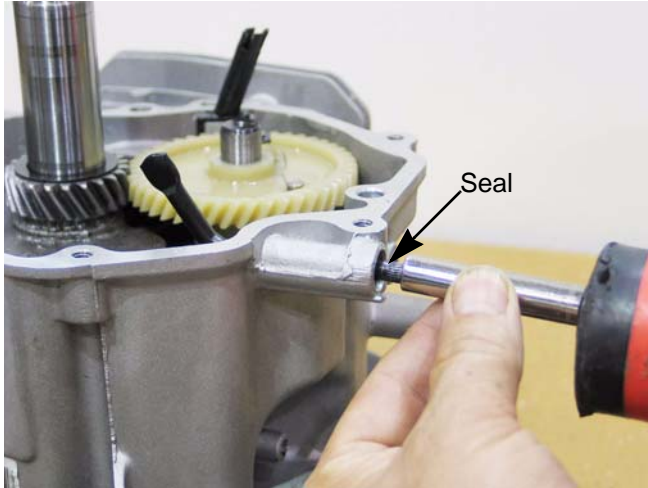

Figure 4.57

- Install the hair pin clip.
- Rotate the governor shaft so that the bent end is standing straight up. See Figure 4.58.



Figure 4.58

NOTE: If the governor shaft is not pointing up while sliding the sump on, the governor shaft will not catch the governor cup. This will prevent the governor from changing the engine rpm and usually presents as an overspeeding engine.

- Install the sump by following the steps described in Chapter 10: Disassembly.
- Rotate the governor shaft clockwise as far as it will go.
- Position the top of the arm about 3/16" (.476cm) from the boss on the casting that provides a mounting point for the fuel tank bracket.
- Install the governor arm by following the steps described in the previous section.
- Install the engine on the unit.
- Test run the engine and adjust the top no load engine rpms by following the steps described in "Disassembly and rebuilding the carburetor" section of this chapter.

Governor cup and the governor gear

- Remove the engine from the unit.
- Remove the sump by following the steps described in Chapter 10: Disassembly.
- Remove the two screws that hold the governor gear plate to the sump using a 10mm wrench. See Figure 4.59.

Remove these screws



Figure 4.59

- Slide the gear shaft out of the gear and cup. See Figure 4.60.

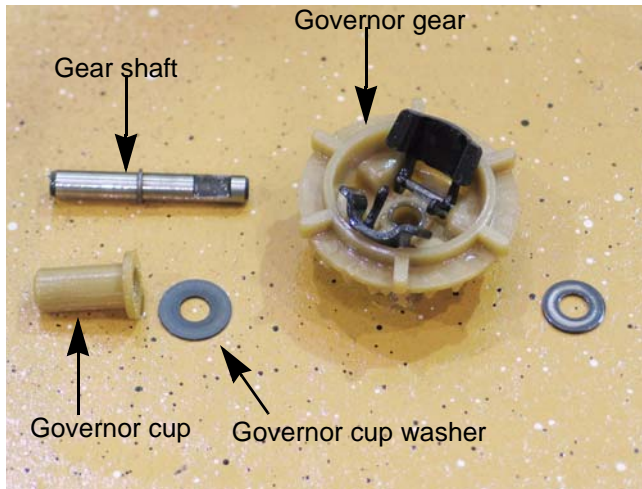

Figure 4.60

- Install by following the above steps in reverse order.
NOTE: Check the governor arm for freedom of movement before test running the engine.
- Test run the engine and adjust the top no load engine rpms by following the steps described in "Disassembly and rebuilding the carburetor" section of this chapter.

References

- Dr. Ullmann, J, Fuels, *Automotive Handbook*, seventh edition. Bosch, Robert distributed by SAE Society of Automotive Engineers, 2007. 320.

Chapter 4: The Fuel System and Governor

CHAPTER 5: LUBRICATION

Oil type and quantity

Use a 4-stroke, or an equivalent high detergent, premium quality motor oil certified to meet or exceed American Petroleum Institute (A.P.I.) requirements for service classification SG/SF. Motor oils classified SG/SF will show this designation on the container.

SAE 10W-30 is recommended for general, all temperature use. If single viscosity oil is used, select the appropriate viscosity for the average temperature in your area from the chart below. See Figure 5.1.

NOTE: A 5w30 synthetic oil may be used to improve startability for cold weather (temperatures below 40 degrees F) after the engine break in period.

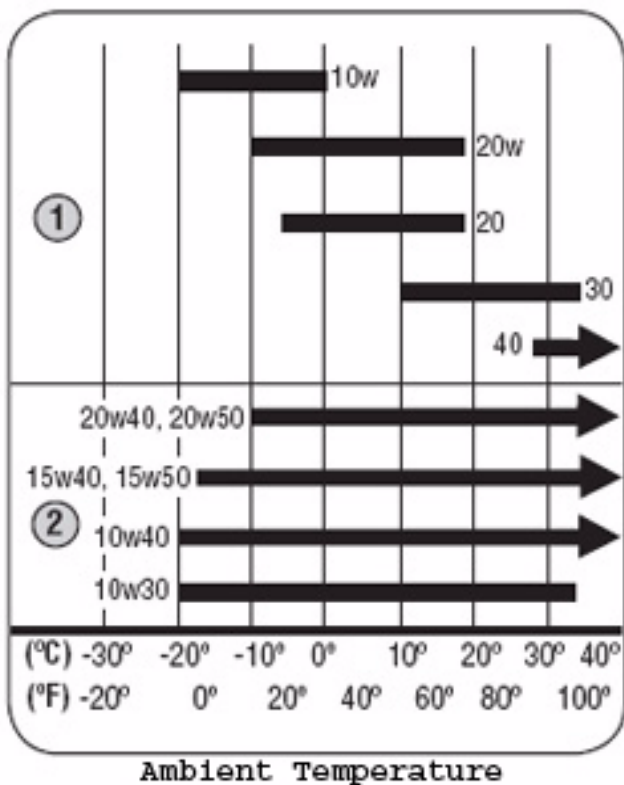

1. Single Viscosity
2. Multi Viscosity

Figure 5.1

NOTE: The oil capacity for these engines is 18 oz (532 cc).

Oil dip stick

To check the oil level:

NOTE: Be sure to check the engine on a level surface with the engine stopped.

1. Remove the oil filler cap and wipe the dipstick clean.
2. Insert the dipstick into the engine block, but do not screw it in. See Figure 5.2.

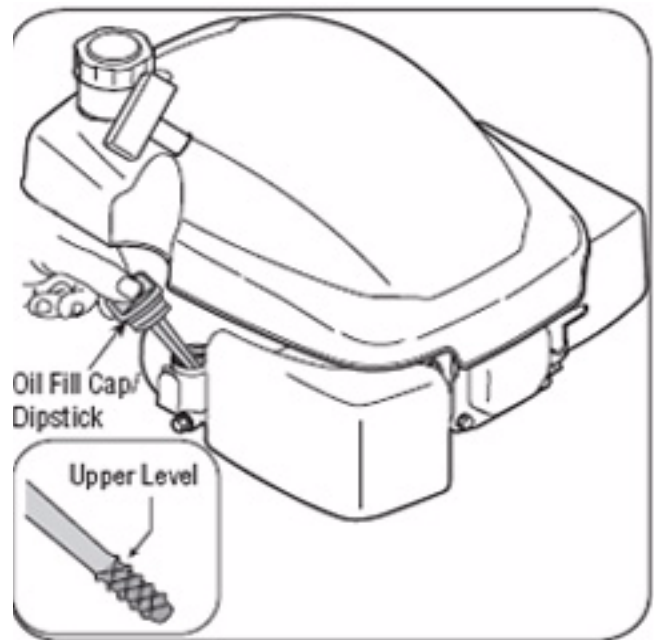

Figure 5.2

3. If the level is low, slowly add oil to the upper limit on the dipstick.

Chapter 5: Lubrication

Dip stick tube removal

Some MTD engines come with a dip stick tube, depending on the application. See Figure 5.3.

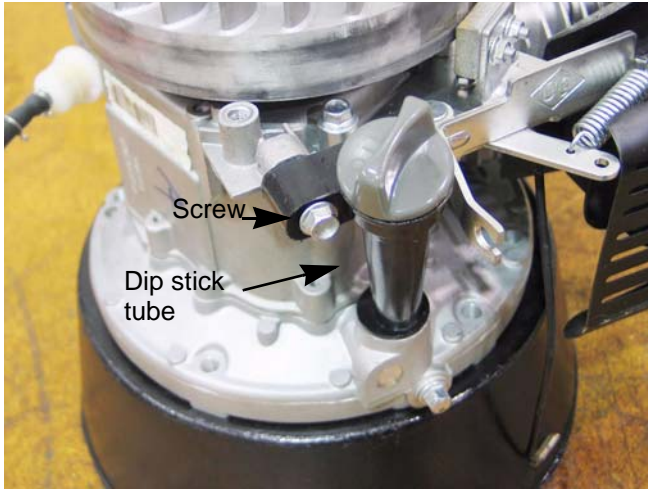

Figure 5.3

To remove/replace the dip stick tube:

1. Remove the dip stick.
2. Remove the screw at the top of the dip stick tube. See Figure 5.3.
3. Pull the dip stick tube out of the engine block.
4. Inspect the O-rings on the dip stick and the dip stick tube. Replace if damaged. See Figure 5.4.



Figure 5.4

5. Install by following the above steps in reverse order.

Lubrication system

MTD uses a splash lube system for its vertical shaft engines. The governor gear has paddles on it that “splashes” oil around the inside of the engine. See Figure 5.5.

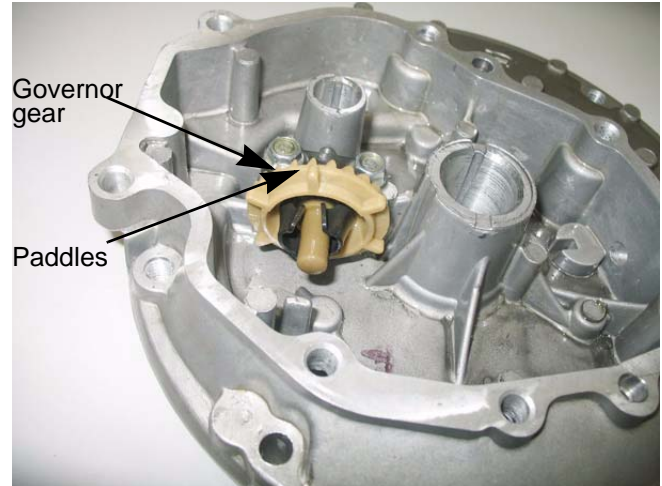

Figure 5.5

The splashing action will also atomize or change the oil into a mist. There are two oil passages that run along the engine cylinder. The one on the top side of the engine is the oil supply passage. The oil mist will flow through this passage to the cylinder head. The supply passage lines up with the top crank arm so that some of the oil on the crank arm will be flung into the supply passage, forcing additional oil up to the cylinder head. See Figure 5.6.

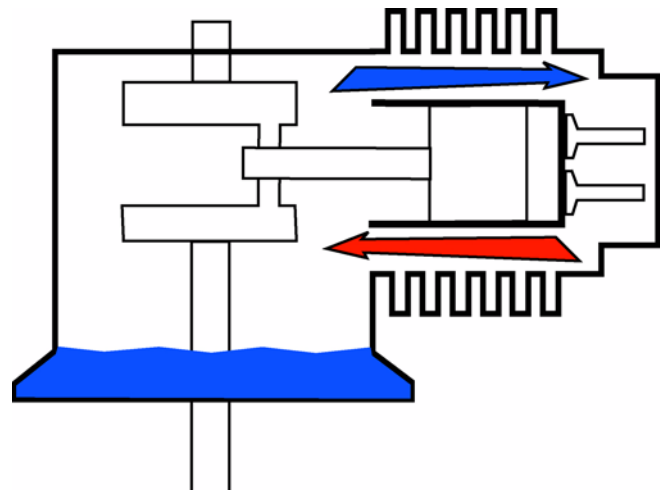

Figure 5.6

The second oil passage runs along the bottom side of the cylinder. This is the oil return passage. As the name implies, it allows the oil collecting in the cylinder head to return to the sump. The return passage can be identified by the plastic drain tube that is attached to it, inside of the engine. See Figure 5.7.

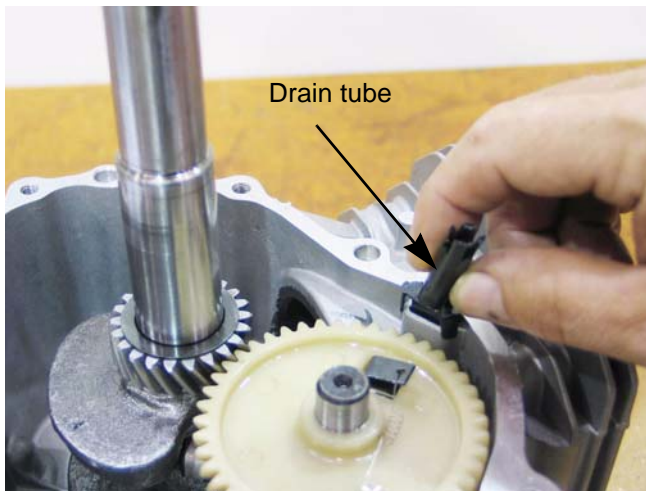

Figure 5.7

NOTE: Not all engine have this drain tube.

NOTE: Because these engines use splash lubrication, the type of oil and the oil level is critical for proper operation of the engine. If the oil level is too low, the paddles on the governor gear can not splash the oil into the engine. If the oil level is too high, the oil will not change into a mist to reach the upper side of the engine.

PCV

The PCV valve is located under the flywheel and allows the crankcase pressure to escape. The function and test procedures for the PCV is covered in Chapter 2: Basic Troubleshooting.

To service the PCV:

1. Remove the flywheel by following the steps described in the Chapter 7: Ignition System.
2. Remove the two screws that hold the PCV chamber cover to the engine block using a 10mm wrench. See Figure 5.8.

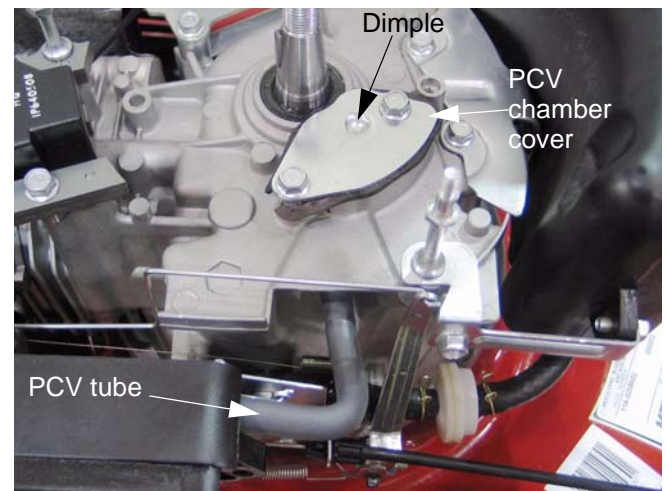

Figure 5.8

Chapter 5: Lubrication

3. The cover and gasket can be separated from the chamber. See Figure 5.9.

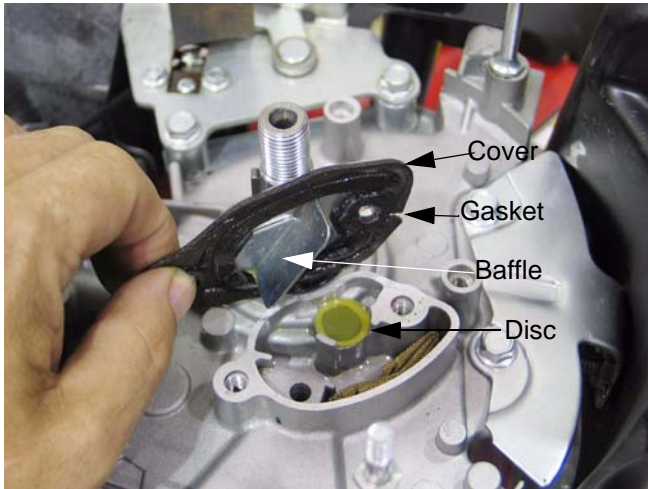

Figure 5.9

NOTE: The dimple in the cover helps locate the fiber disc over the port that leads into the crankcase.

NOTE: Starting with the 2009 season, a spring was added to help hold the disc in the closed position. See Figure 5.10.



Figure 5.10

4. Inspect the disc for any signs of dirt, damage or leaking.
5. Inspect the folded wire mesh in the chamber. See Figure 5.11.

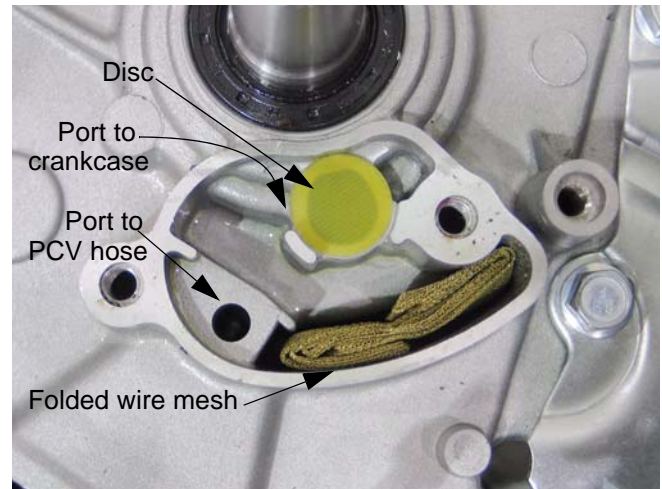

Figure 5.11

6. Inspect the oil drain-back port. Make sure it will allow oil to drain back into the engine. See Figure 5.12.

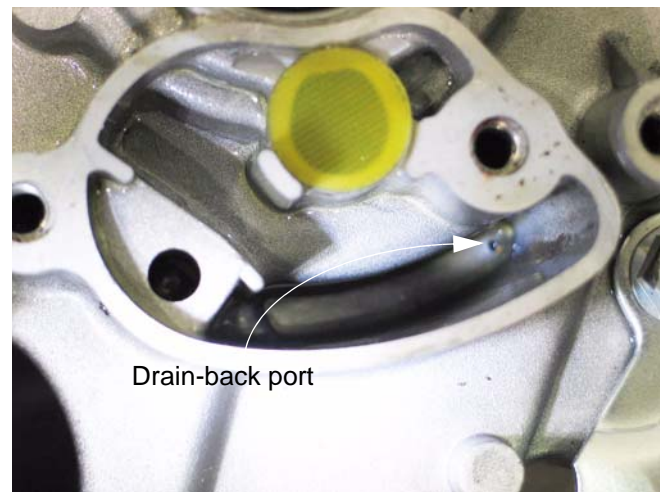

Figure 5.12

7. Reassemble the PCV.
8. Tighten the cover bolts to a torque of 27 in-lbs. (3 Nm).
9. Inspect the PCV tubing for cracks, brittleness or signs of leaking. Replace the PCV tube if any are found. See Figure 5.13.

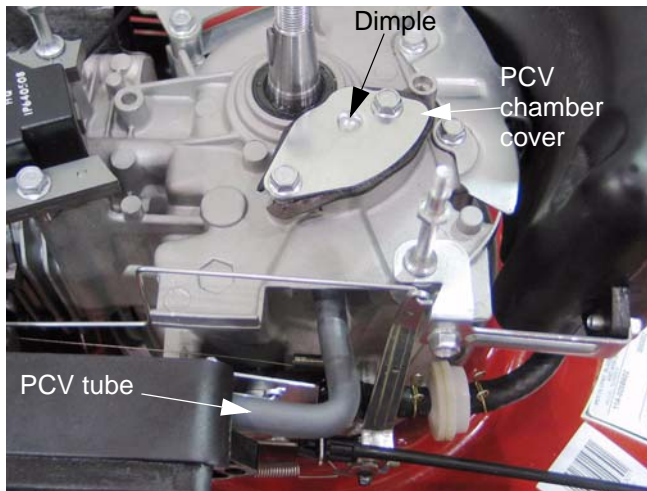

Figure 5.13

10. Re-assemble the engine by following the above steps in reverse order.
11. Test run the engine before returning to service.

Chapter 5: Lubrication

CHAPTER 6: STARTERS

Recoil Starter Removal

To remove recoil assembly from the engine:

NOTE: Some engines are not equipped with an engine shroud, depending on the application. If the engine does not have an engine shroud, skip to step 5.

1. Loosen the wingnut, that secures the starter rope eyelet to the handlebars, enough to provide clearance for the starter rope and slide the rope out. Allow the starter rope to retract into the starter..
2. Remove the four screws that hold the engine shroud to the engine. See Figure 6.1.

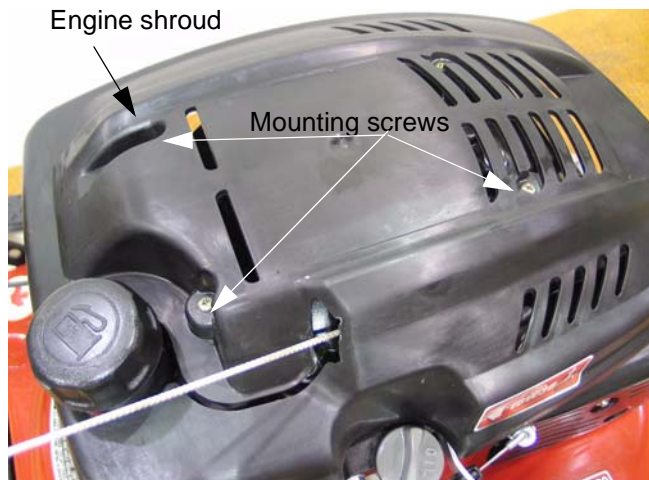

Figure 6.1

3. Remove the fuel cap.

CAUTION: Use common sense when working around fuel: No sources of sparks or open flame should be near enough to cause ignition.

4. Lift the shroud off of the engine.

5. Remove the engine cover and replace the fuel cap.
6. Remove the three nuts that secure the recoil assembly and fan shroud to the engine using a 10mm wrench. See Figure 6.2.

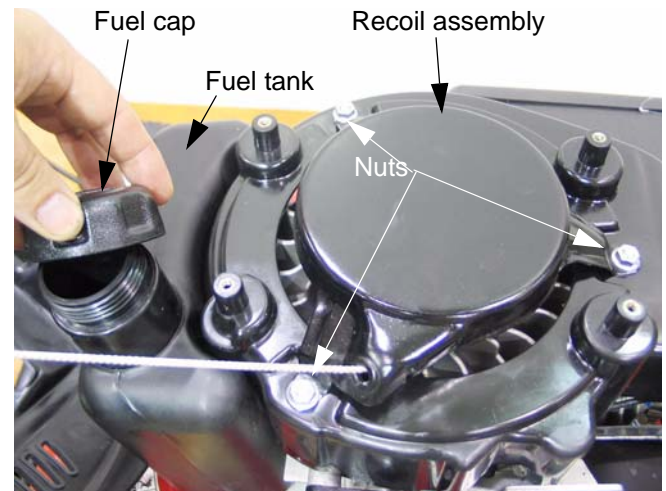

Figure 6.2

7. Lift the recoil assembly off of the engine, and place it on a convenient work surface.

Chapter 6: Starters

Starter Cup

The starter cup can either be cast into the flywheel or be a steel cup that is bolted to the flywheel depending on the application.

1. Inspect the inside of the starter cup.
See Figure 6.3.

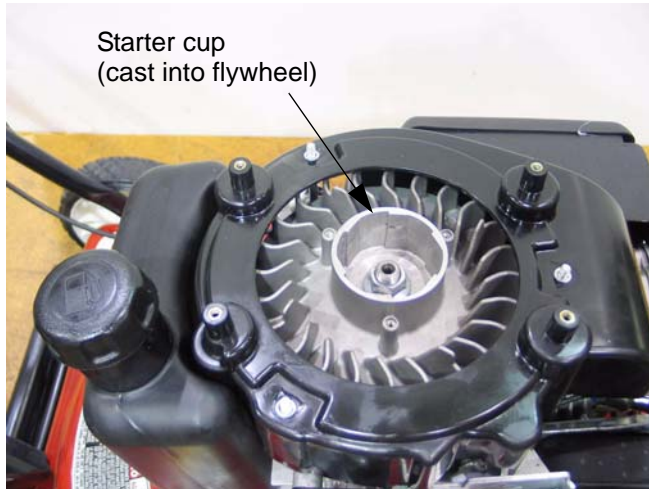

Figure 6.3

NOTE: If the starter was failing to engage the flywheel, and the edges of the teeth inside the cup are rounded, replace the flywheel or starter cup.

NOTE: If the flywheel or starter cup is replaced, the complete starter should be replaced as well, to prevent a repeat failure.

2. If the engine has a steel starter cup, remove it by removing the flywheel nut.

3. Install a starter cup by placing the starter cup on the flywheel allowing the protrusion on the bottom of the starter cup to rest inside the dimple in the flywheel. See Figure 6.4.

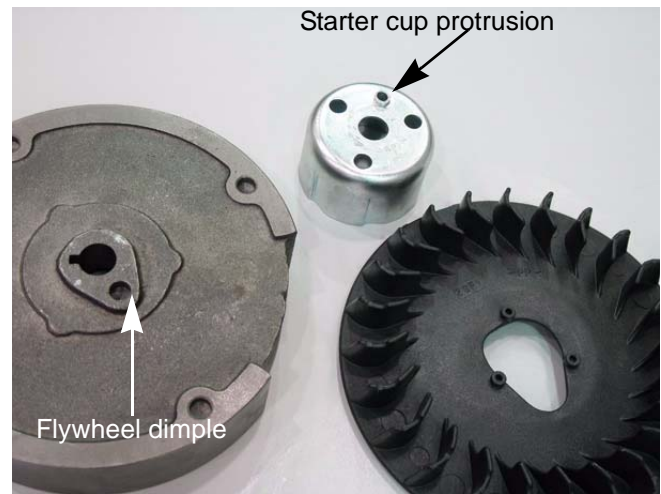

Figure 6.4

4. Install the flywheel nut and tighten it to a torque of 47 - 52 ft-lbs (64-70 Nm).

Starter Rope

The most common failure mode for most recoil assemblies is a broken rope. See Figure 6.5.

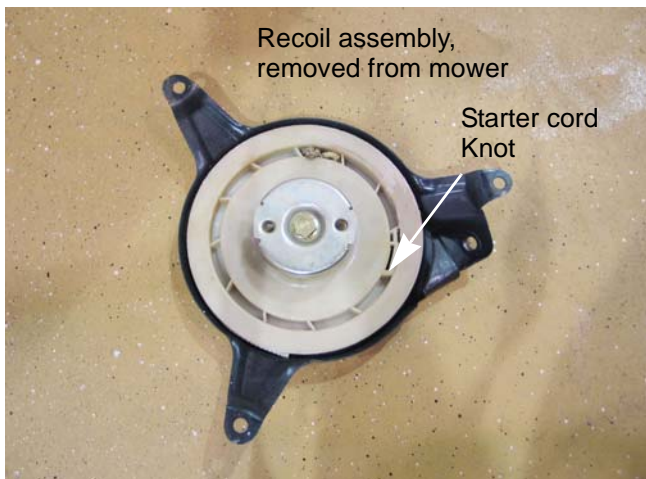

Figure 6.5

NOTE: If the spring was not damaged when the recoil sprung back, It is possible to simply remove the remnants of the old rope.

1. Remove the starter by following the steps described earlier in this chapter.
2. Remove the old starter rope by prying out the starter cord knot and pulling the rope out with it.
3. Cut a piece of #4 recoil rope 9' (3 meters) long.
4. Heat fuse the ends of the starter rope, and tie a double half-hitch in one end.
5. The rope may be easily installed from the inside-out. Pull the rope tight to seat the knot firmly in the recess in the back of the pulley. See Figure 6.6.

6. Wind the spring completely. Then relieve it minimum 1 full turn, counting when the pulley knot aligns with the rope bushing in the housing. (This usually results in about 1.5-1.75 complete turns of relief), and secure it with a spring clamp. See Figure 6.6.

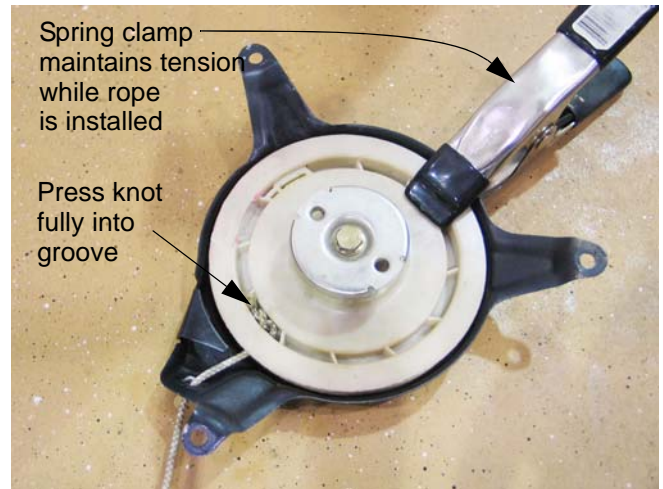

Figure 6.6

7. Install the handle and handle insert on the loose end of the rope, again using a double half-hitch. See Figure 6.7.

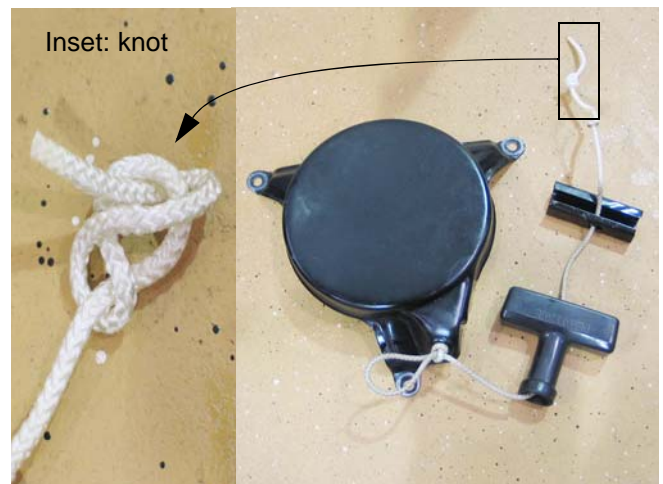

Figure 6.7

8. Remove the spring clamp and carefully let the rope rewind into the starter.
9. Give the starter a couple of test pulls to verify the right amount of tension on the starter rope.

Chapter 6: Starters

NOTE: If starter rope tension needs to be adjusted, there is room between the recoil housing and the pulley to wind-on more tension. See Figure 6.8.

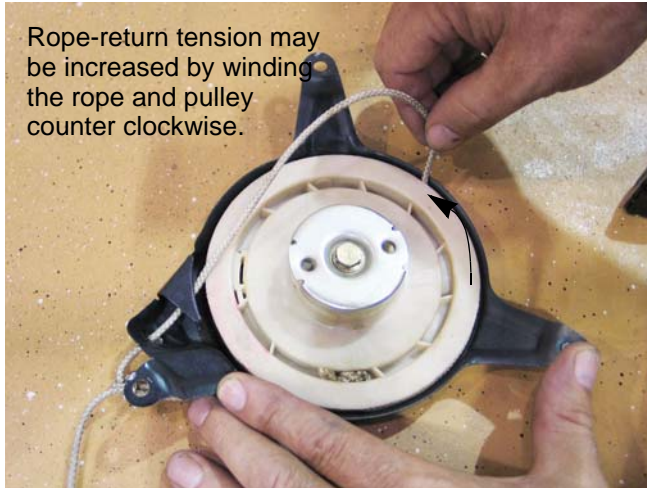

Figure 6.8

10. Install the starter and tighten the starter nuts to a torque of 80-106 in-lbs (9-12 Nm).

Starter pulley and recoil spring

The recoil spring is nested within the starter pulley and both parts are assembled as a single part number.

CAUTION: Eye protection should be worn if the starter pulley is to be removed.

If damage is suspected, the recoil may be disassembled by:

1. Remove the starter by following the steps described earlier in this chapter.
2. Remove the shoulder screw and pressure plate using a 10 mm wrench. See Figure 6.9.

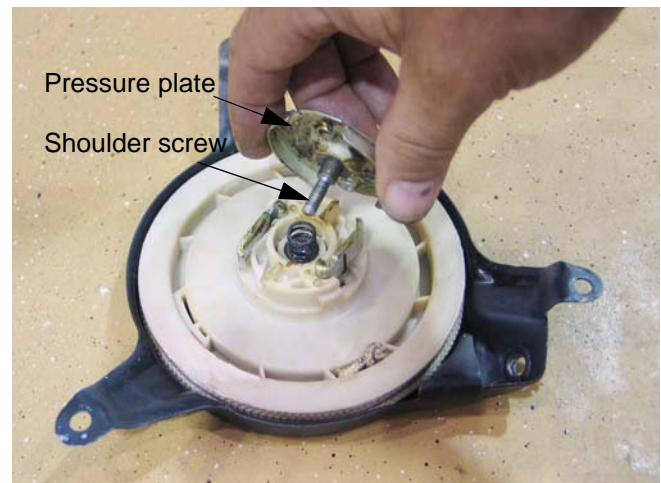

Figure 6.9

NOTE: Beneath the pressure plate is a compression spring, and two starter pawls that are held in the disengaged position by two torsion springs.

3. Inspect the pawls and torsion springs for wear and damage. See Figure 6.10.

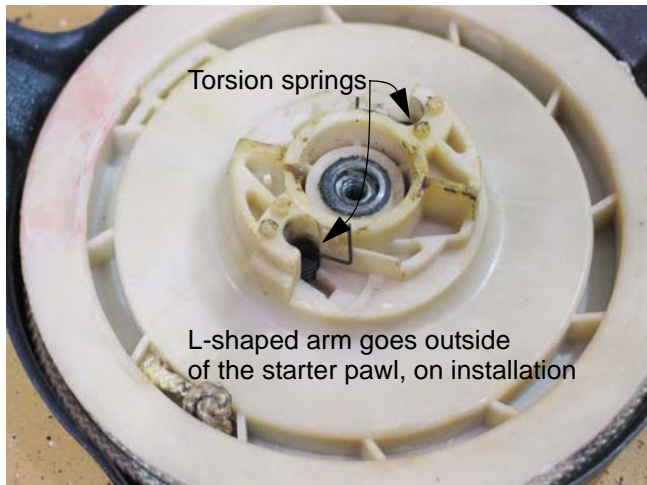

Figure 6.10

4. Carefully lift the spring and pulley out of the recoil housing. See Figure 6.11.

CAUTION: The recoil spring is under tension and can release as the pulley is removed.

CAUTION: Eye protection should be worn while removing the starter pulley.

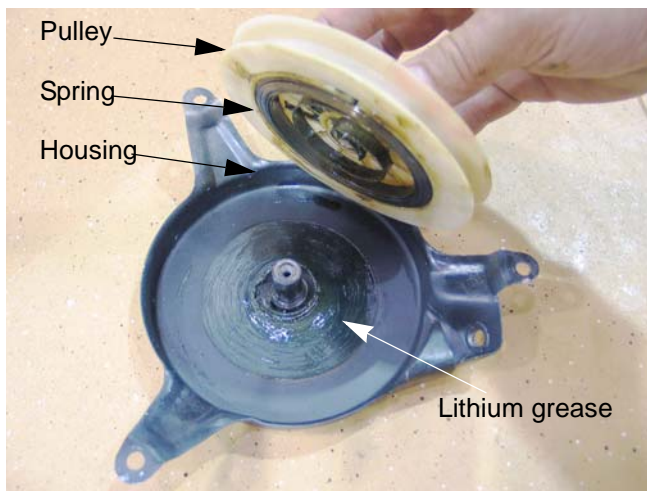

Figure 6.11

NOTE: If the spring is undamaged, but has been removed from the pulley, the spring may be re-wound. Engage the hook in the end of the spring with the slot in the outer lip of the recess that the spring fits in, and wind the spring into the recess in a counter-clockwise direction.

NOTE: Evaluate the damage, including parts prices and local labor rates. In some parts of the country, it makes economic sense to replace the complete assembly, in other areas labor rates favor repair.

5. To re-assemble, apply a small amount of lithium-based chassis grease to the surface of the recoil housing that contacts the spring.
6. Carefully position the pulley and spring in the recoil housing. Rotate the pulley gently counter-clockwise until the spring seats, allowing the pulley to fall into position.
7. Install the torsion springs and pawls so that the long arm of the spring reaches outside of the pawl, and draws it toward the center of the assembly. See Figure 6.12.

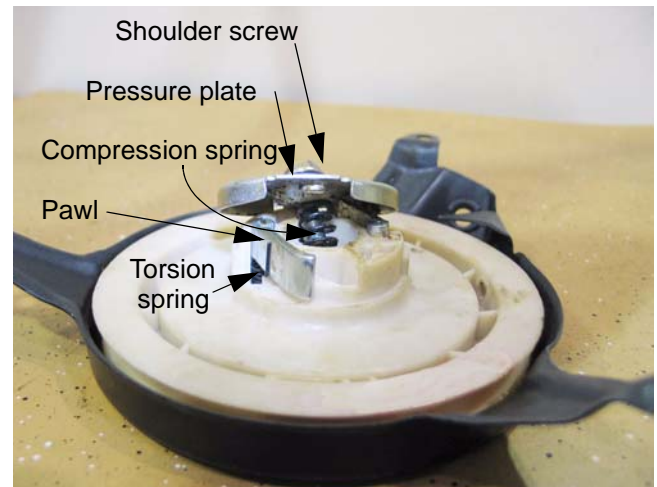

Figure 6.12

NOTE: The rolled end of the pawl fits in the recess in the starter pulley. The hooked end engages the starter cup. Both the roll and the hook face inward.

NOTE: The extrusions on the pressure plate should fall inside of the pawls as the starter is assembled.

NOTE: Drag on the pressure plate, from the friction between the compression spring and the head of the shoulder screw causes these extrusions to force the pawls outward, engaging the starter cup.

Chapter 6: Starters

8. Apply a small amount of thread locking compound such as Loctite 242 (blue) to the threads of the shoulder screw, and install the screw. Tighten it to a torque of 71 - 89 in-lb. (8 - 10 Nm).
9. Install the starter rope by following the steps described in the previous section of this chapter.
10. Install the starter and tighten the starter nuts to a torque of 80-106 in-lbs (9-12 Nm).

Electric starter relay

The electric starter on the MTD engine uses a relay that acts as a remote switch instead of a solenoid, which would also move the bendix gear out to engage the flywheel. The bendix gear on this starter will move to engage the flywheel by centrifugal force. The relay is mounted on the side of the engine, next to the oil dip stick. See Figure 6.13.

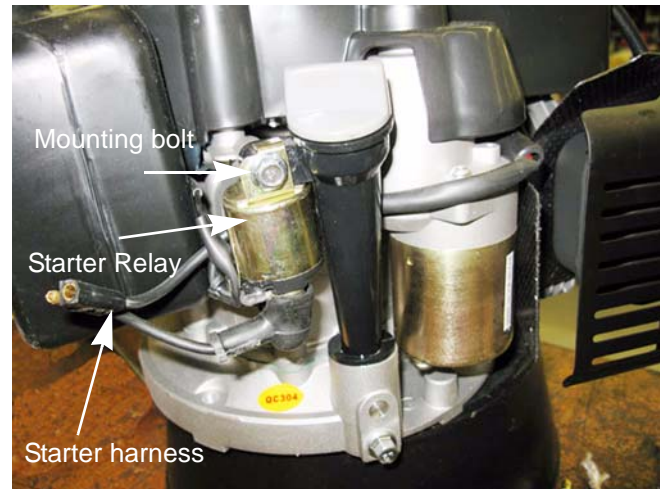

Figure 6.13

To remove/replace the starter relay:

1. Unplug the starter harness. See Figure 6.13.
2. Remove the screw that secures the relay and dip stick tube using a 10mm wrench.
3. Disconnect the two 12 AWG wires from the bottom of the relay.

4. Disconnect the relay's ground lead from the middle tab of the blade brake switch. See Figure 6.14.

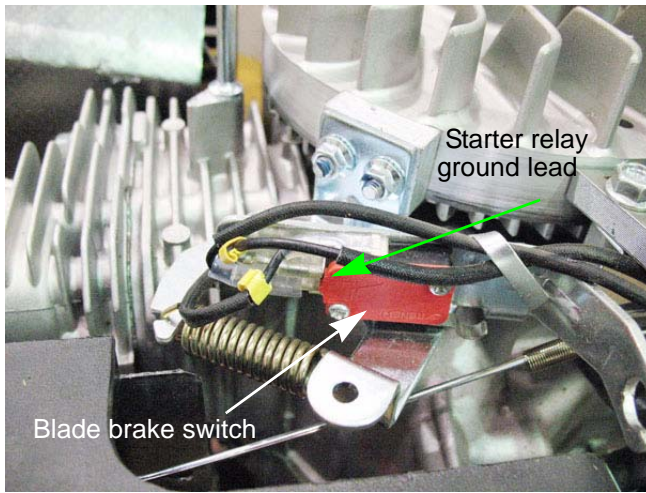

Figure 6.14

5. Work the lead out of the two retaining clips.
6. Install the relay by following the previous steps in reverse order.
7. Test run the engine before returning it to service.

Testing the starter relay

To test the starter relay:

1. Unplug the starter harness.
2. Unbolt the relay from the engine.
3. Disconnect the two 12 AWG wires from the bottom of the relay.
4. Disconnect the relay's ground lead from the middle tab of the blade brake switch. See Figure 6.14.
5. Connect a digital multimeter (DMM), that is set to the Ohms (Ω) scale, to the two terminals on the bottom of the relay. See Figure 6.15.



Figure 6.15

NOTE: The DMM should read no continuity or open line.

Chapter 6: Starters

6. Connect the ground lead to the ground side of a 12V power source. See Figure 6.16.

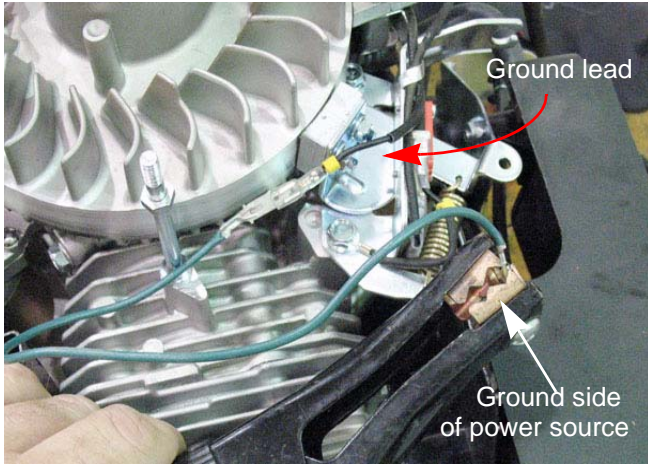

Figure 6.16

7. Connect the positive side of the power source to the terminal that has the piggy back wire on it. See Figure 6.17.



Figure 6.17

8. Reconnect the DMM with it still on the Ohms (Ω) scale. See Figure 6.18.

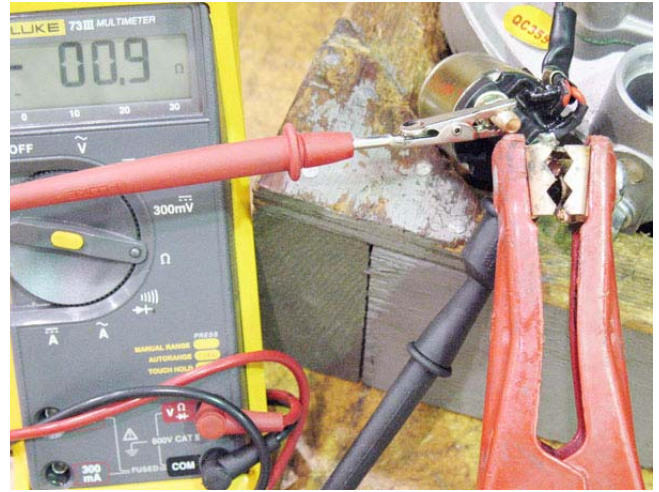

Figure 6.18

- NOTE:** The DMM should read less than 0.2 Ohms (Ω). This relay has a burnt contact.
9. If the test results do not match what was listed above, replace the relay.

Electric starter

To remove/replace the electric starter:

1. Disconnect the engine harness.
2. Remove the screw that secures the starter relay and oil dip stick tube to the engine block using a 10mm wrench. See Figure 6.19.



Figure 6.19

3. Remove the dip stick.
4. Remove the two screws that secure the starter using a 10mm wrench. See Figure 6.20.



Figure 6.20

NOTE: If replacing the starter, make sure both dowel tubes are in the engine block. See Figure 6.21.

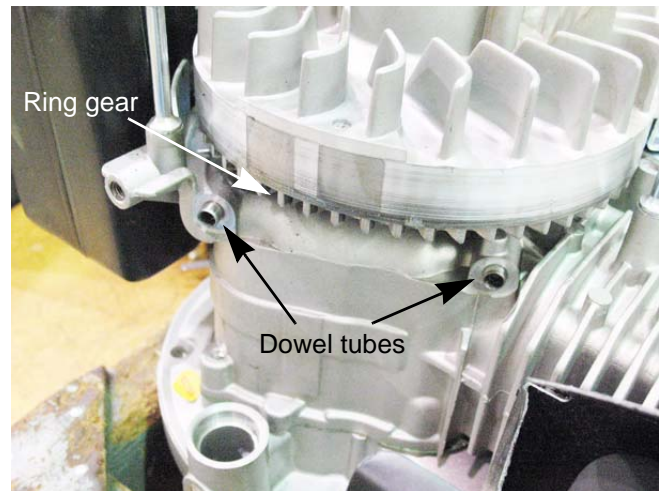

Figure 6.21

NOTE: The ring gear is cast into the flywheel.

5. Install the starter by following the previous steps in reverse order.
6. Test run the engine before returning it to service.

Chapter 6: Starters

Schematic

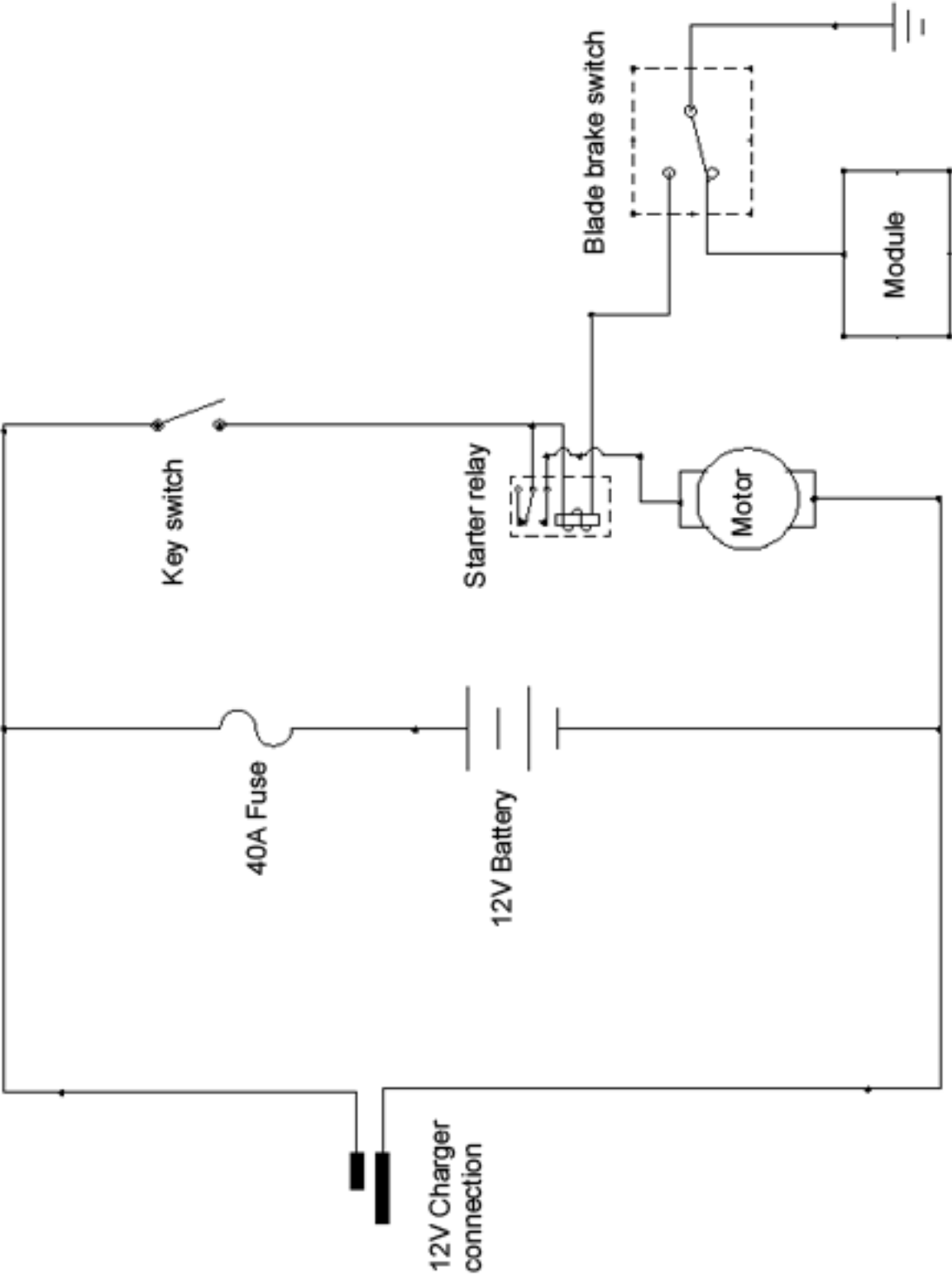

CHAPTER 7: IGNITION SYSTEM

Trouble shooting the ignition system

The purpose of the ignition system is to provide a spark in the combustion chamber at the proper time to ignite the fuel/air mixture. The first step in troubleshooting the ignition system is:

1. Examine the spark plug(s) by following the steps described in the spark plug section of the chapter.
2. Test the ignition system:

After examining the spark plug reinstall it, or a new one to ensure a good spark plug is being used. Now the ignition can be tested to verify spark is getting to the spark plug. To test the system:

- 2a. Disconnect the spark plug wire.
- 2b. Connect a spark tester to the spark plug wire.
- 2c. Connect the other end of the spark tester to the engine block. See Figure 7.1.

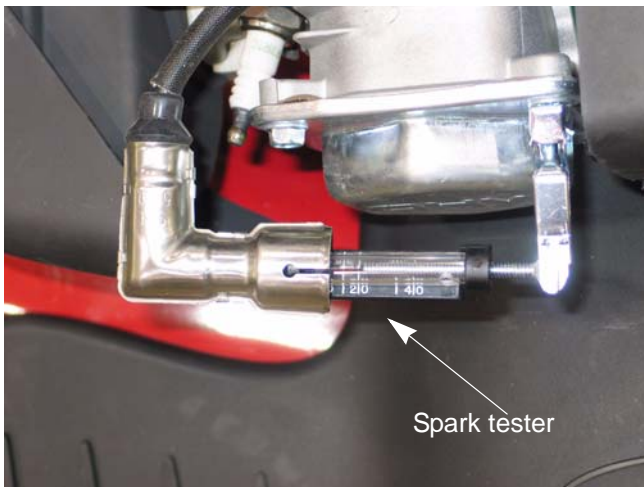

Figure 7.1

CAUTION: Never remove the spark plug and hold it against the cylinder head to test for spark. The fuel/air mix coming out of the spark plug hole will catch on fire.

NOTE: It only takes 1,000 volts to jump a .025" air gap in open atmosphere, it takes 10,000 volts to jump the same gap at 120 psi, therefore an open air spark test is not valid.

NOTE: The spark should be a minimum of 10 Kv (10,000 volts) at pull over speed.

- 2d. Squeeze the safety bail and pull the starter rope. Watch the spark tester. If sparks are seen in the spark tester, the ignition system is working.

NOTE: If there are sparks present in the spark tester, check the spark plug again. If it is wet the spark plug is defective. If the spark plug is dry, the problem is not in the ignition system. Check the engine's compression.

- 2e. If no sparks are seen in the spark tester further testing is required.

3. Test the stop switch:

NOTE: the stop switch could be mounted near the carburetor or if the engine is equipped with an engine brake, the stop switch will be located on the engine brake. The switch is designed to ground out the module.

To test the stop switch:

- 3a. Locate the terminal that connects the stop switch wire to the primary windings of the ignition module. See Figure 7.2.

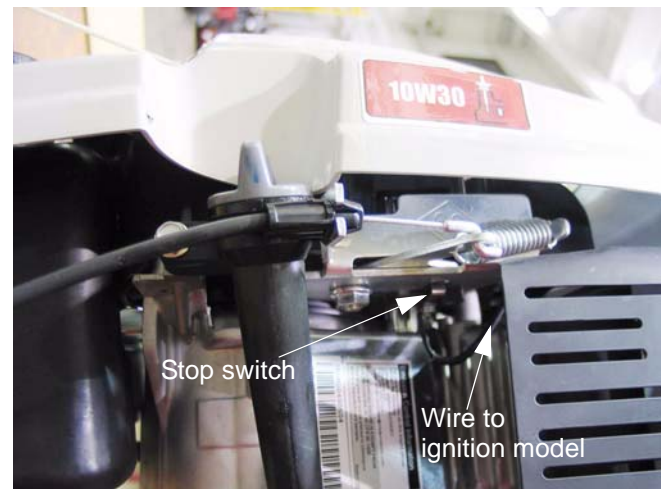

Figure 7.2

Chapter 7: Ignition System

- 3b. Connect an Ohm meter between the terminal and a ground point. The reading should approach zero when the bail is released or the switch is turned off, closing the contacts. See Figure 7.3.



Figure 7.3

NOTE: If the reading is high, the contacts may be burnt or there is a bad ground to the switch. This could prevent the engine from shutting down rapidly.

- 3c. The reading should be high when the bail is pulled down or the switch is in the run position, reflecting the resistance in the primary windings of the ignition module. See Figure 7.4.

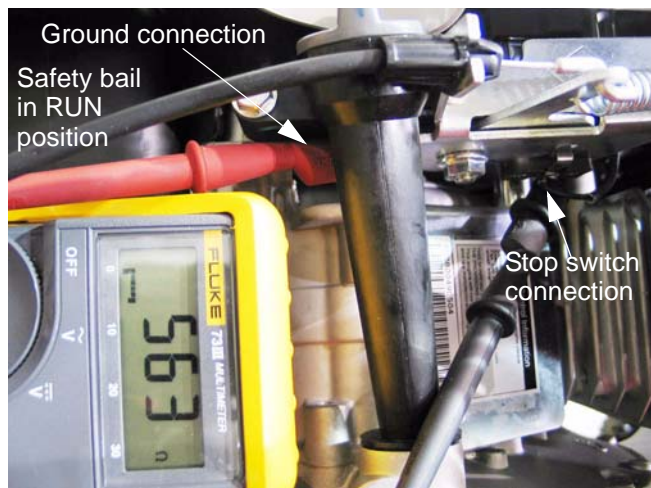

Figure 7.4

NOTE: If the reading is low, the module is shorted to ground and may not produce a spark. The wire will need to be traced back to the module to find the short.

- 3d. Alternatively, a jumper wire could be connected to the same locations. Use a commercially available spark checker to see if the ignition is working or not.

- If the jumper disables the ignition, but releasing the bail does not, the problem lies in the switch.
- If the jumper does not disable the ignition, then the wire that connects the switch to the ignition module may have a fault, or the ignition module itself may be faulty. Further investigation is required.
- If the problem is a lack of spark when the bail is pressed against the upper handlebar, disconnect the wire from the switch using a 7mm wrench. Isolate the wire from incidental contact with ground, and test the ignition. If it fails to spark, the wire may be shorted or the ignition may be at fault. Further investigation is required.

- 3e. If further investigation is required, remove the recoil assembly by following the steps described in Chapter 6: Starter.

- 3f. Visually trace the wire from the stop switch to the connector on the module, and inspect the wire for any damaged insulation or potential contact with ground.

- 3g. Unplug the wire from the spade terminal on the module or unplug the insulated bullet connectors, depending on the production date of the engine, and check continuity to ground from the female terminal on the wire from the switch. Resistance (Ohms) should be zero with the bail released or the switch turned off. See Figure 7.5.



Figure 7.5

Chapter 7: Ignition System

- 3h. Resistance (Ohms) should be infinite (O.L) with the bail released. See Figure 7.6.



Figure 7.6

- 3i. If the switch and wire work properly, and the connection is good at the spade terminal, but releasing the bail or turning off the switch fails to stop the engine, then the problem lies within the module.
4. The module
- 4a. Normal performance of the coil is to produce at least 10,000 volts at starter-rope pull-through speed. See Figure 7.7.



Figure 7.7

- 4b. Presence or absence of strong spark, with the stop switch and wire known to be good, is generally enough to identify the ignition coil as good or bad. Resistance readings may help confirm the source of the failure, but are generally meaningless because they only measure a small part of the module.

NOTE: Presence of a weak spark maybe the result of an improper air gap. The air gap space should be .008”-.016” (.2-.4mm).

- 4c. Simple spark-testers are readily available and inexpensive. Thexton Part # 404 is available from a variety of retailers, and similar units are available form other manufacturers. See Figure 7.8.



Figure 7.8

Chapter 7: Ignition System

- 4d. At operating speed, the ignition should produce voltage approaching 12,000. See Figure 7.9.



Figure 7.9

- 4e. At pull-over speed (\approx 600 RPM), voltage should be at least 10,000V. See Figure 7.10.



Figure 7.10

NOTE: Flash-over voltage will vary with spark plug condition and gap.

NOTE: Pull-over speed may vary from operator to operator.

- 4f. Resistance in the primary windings of the ignition module, measured between the spade terminal and the laminations, was observed to be in the 550-650 Ω range. See Figure 7.11.



Figure 7.11

- 4g. Resistance in the secondary windings of the ignition module, measured between the spark plug terminal and the laminations, was observed to be in the 8K-9K Ω range. See Figure 7.12.

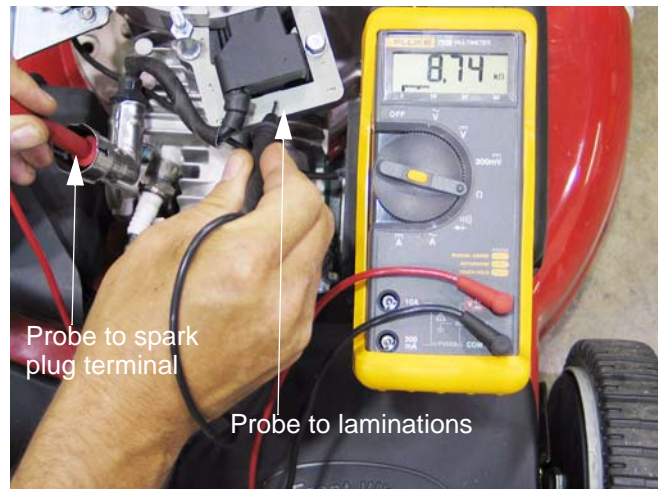

Figure 7.12

NOTE: There may be slight variation in specification due to production variation and other factors such as temperature.

Chapter 7: Ignition System

- Resistance figures that are vastly lower may indicate a short in the windings being tested.
- Resistance figures that are vastly higher (or O.L) may indicate a fault in the windings being tested.

NOTE: Intermittent failure requires tests for voltage and resistance to be made when the engine is cold, and again when it is hot. Typical customer complaint: "It stops after I mow for 10 minutes and I can't get it to re-start".

- To confirm that the problem is ignition-based, it is necessary to "catch it in the act".
- Resistance normally increases slightly as temperature increases.

NOTE: Failure of the magnets in the flywheel is exceedingly rare. To test the magnets, simply hold an item made of ferrous metal roughly 1/4" (.635cm) away from the magnets in the flywheel. It should be drawn to the flywheel. A wrench or screwdriver is suitable for this test.

NOTE: An inexpensive compass or bar magnet can be used to confirm opposite polarity of the flywheel magnets. See Figure 7.13.

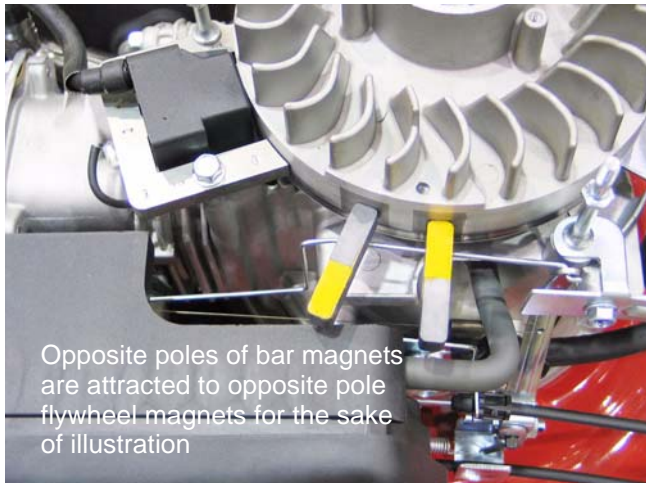

Figure 7.13

5. Inspect the flywheel.

The flywheel is a frequently forgotten component of the ignition system. It holds the magnets that induce a field in the module which in turn produces a spark. But it also controls the timing of the ignition system by controlling when the magnets are introduced to the module.

A sheared flywheel key will throw off the ignition timing. To inspect the flywheel and key:

1. Remove the recoil assembly by following the steps describe in Chapter 6: Starter.
2. Remove the flywheel by following the steps described in the flywheel section of this chapter.
3. Inspect the flywheel key and the key way on the crank shaft.

NOTE: If the flywheel key is damaged, replace it. If the keyway on the crankshaft is damaged, the engine must be short blocked.

Chapter 7: Ignition System

About the spark plug

- The spark plug is a Torch model F6RTC, gapped to .024"-.032" (.60-.80 mm).
- Champion RN14YC or NGK BPR4ES are physically similar but do not match the F6RTC in heat range. This difference in heat ranges will effect performance and emissions. It is recommended that the Torch F6RTC plug be used for service.
- Wear rate will vary somewhat with severity of use. If the edges of the center electrode are rounded-off, or any other apparent wear / damage occurs, replace the spark plug before operating failure (no start) occurs.

Cleaning the spark plug

- Cleaning the spark plug is not recommended. If the plug needs to be cleaned, replace it.
- Use of a wire brush may leave metal deposits on the insulator that cause the spark plug to short-out and fail to spark.
- Use of abrasive blast for cleaning may damage the ceramic insulator or leave blast media in the recesses of the spark plug. When the media comes loose during engine operation, severe and non-warrantable engine damage may result.

Inspection of the spark plug

Inspection of the spark plug can provide indications of the operating condition of the engine.

- Light tan colored deposits on insulator and electrodes is normal.
- Dry, black deposits on the insulator and electrodes indicate an over-rich fuel / air mixture (too much fuel or not enough air)
- Wet, black deposits on the insulator and electrodes indicate the presence of oil in the combustion chamber.
- Heat damaged (melted electrodes / cracked insulator / metal transfer deposits) may indicate detonation.
- A spark plug that is wet with fuel indicates that fuel is present in the combustion chamber, but it is not being ignited.

Spark plug removal

1. Disconnect and ground the spark plug wire.
2. Remove the spark plug using a 13/16" or 21mm wrench. A flexible coupling or "wobbly" extension may help. See Figure 7.14.

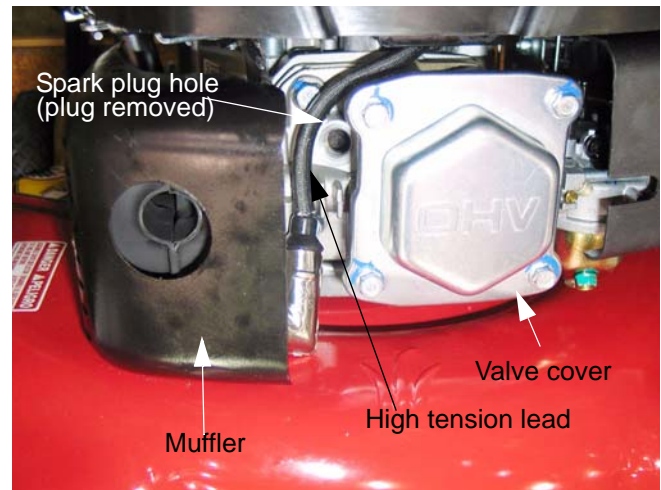

Figure 7.14

3. Gap a new spark plug to .024"-.031" (.60-.80 mm).
4. Install the new spark plug and tighten to a torque of 15 - 18.5 ft - lbs (20-25 Nm).

Ignition module

The ignition system is either a capacitive discharge or a inductive discharge magneto, depending on the application, contained in a single module.

- The capacitive discharge has a three leg design.
- The inductive discharge magneto has a two leg design.
- The magneto is energized by the passing of a pair of magnets mounted in the flywheel.
- Ignition timing is set by the location of the flywheel in relation to the crankshaft. Proper timing is maintained by a steel key.

NOTE: Regardless of which type of magneto is used, the test procedures are the same.

Module removal

1. Unplug the spark plug.
2. Remove the recoil assembly by following the steps described in Chapter 6: Starter.
3. Lift the fan shroud off of the three studs that locate it. See Figure 7.23.

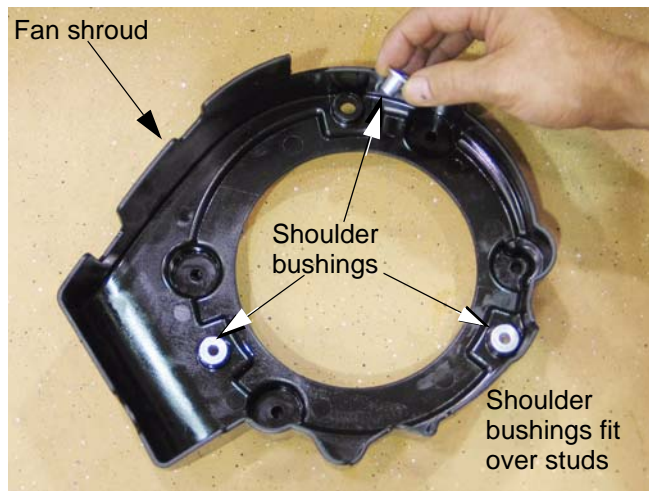

Figure 7.15

4. Unplug the wire from the spade terminal on the module or unplug the insulated bullet connectors, depending on the production date of the engine.
5. Remove the module using a 10mm wrench.

Installing the module and setting the air gap

NOTE: If just setting the air gap, loosen the module mounting screws first then follow the same steps as described below.

1. Rotate the flywheel so that the magnets are away from where the module is mounted.
2. Install the module. Do not tighten the module down.
3. Place a non-ferrous feeler gauge between the module and the flywheel. See Figure 7.16.

NOTE: The air gap should be .008"-.016" (.2-.4mm).

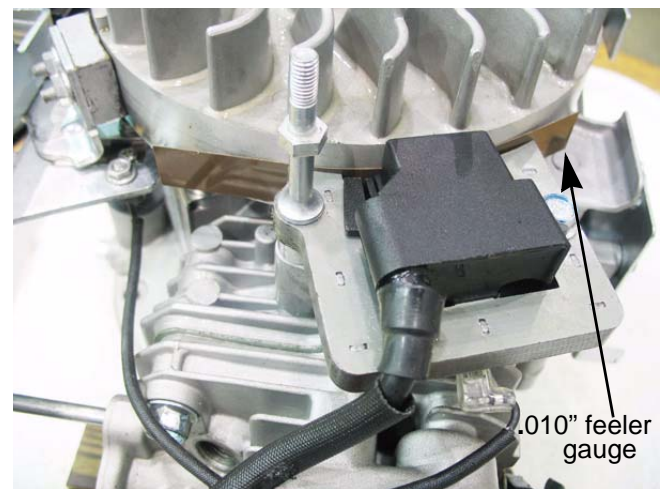

Figure 7.16

4. Rotate the flywheel so that the magnets align with the legs of the module while holding the feeler gauge in place. See Figure 7.17.

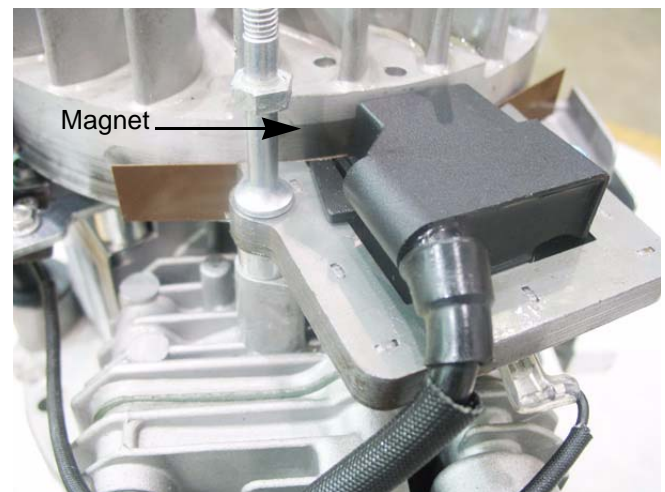

Figure 7.17

Chapter 7: Ignition System

5. Tighten the module mounting screws to a torque of 18.5 ft-lbs (10Nm).
6. Rotate the flywheel to remove the feeler gauge.
7. Install the blower housing and starter.
8. Connect the spark plug wire to the spark plug.
9. Test run the engine before returning to service.

Engine brake and stop switch (if equipped)

The stop switch and brake (for lawn mower applications) must be able to stop the blade from rotating within 3.0 seconds after the release of the safety bail, per ANSI B71.1-2003 standard.

NOTE: The brake should be replaced when the thickness of the pad is less than .25" (6.35mm) at the thinnest spot.

To replace the brake assembly:

1. Disconnect and ground the spark plug wire.
2. Remove the recoil assembly and blower housing by following the steps described in Chapter 6: Starter.
3. Remove the flywheel by following the steps described later in this chapter.
4. Remove the engine control cable by:
 - 4a. Squeeze the barbs together at the engine end of the cable housing and push it through the brake assembly.
 - 4b. Unhook the Z-fitting from the brake assembly. See Figure 7.18.



Figure 7.18

Chapter 7: Ignition System

5. Disconnect the connector in the lead that goes to the module.
6. Remove the two bolts securing the brake assembly. See Figure 7.19.

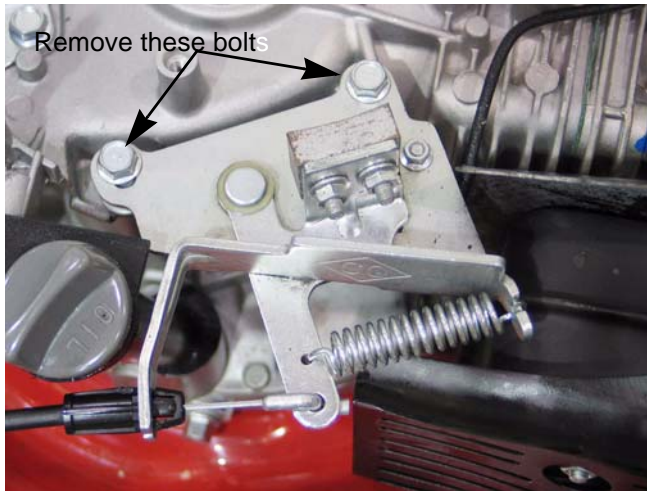

Figure 7.19

To install a brake assembly:

1. Set brake in place and loosely tighten the bolts.
2. Install the flywheel by following the steps describe in a later section of he chapter.
3. Install the control cable.
4. Adjust the brake assembly by following the steps described in the next section of this chapter.
5. Install the blower housing and recoil assembly by following the steps described in Chapter 6: Starter.
6. Test run the engine in a safe area before returning it to service.

Adjusting the brake assembly (if equipped)

1. Disconnect and ground the spark plug wire.
2. Remove the recoil assembly and blower housing by following the steps described in Chapter 6: Starter.
3. Slightly loosen the two bolts that holds the brake assembly in place using a 10mm wrench.

NOTE: The bolt near the cylinder is a pivot point and the bolt by the dip stick is in a slot. See Figure 7.20.

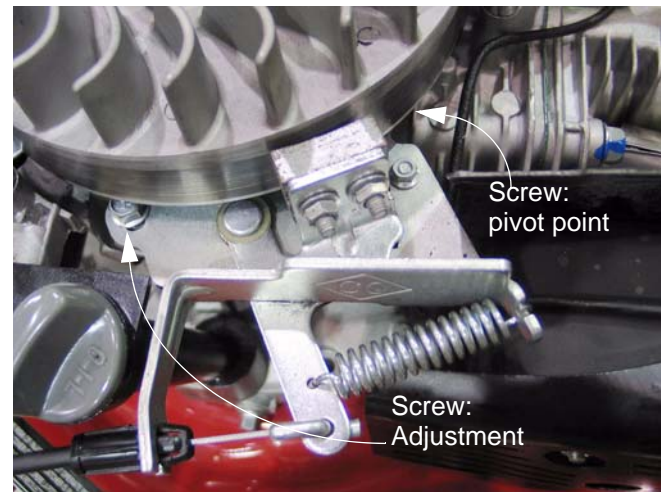

Figure 7.20

4. Use a spring clamp to hold the safety bail against the upper handle bar.

Chapter 7: Ignition System

5. Position the brake assembly so that the edge of the brake pad that is nearest the slotted hole is roughly .050" (1.27mm) from the flywheel, then tighten the screws. See Figure 7.21.

NOTE: The shank of an unused drill bit may be used as a feeler gauge



Figure 7.21

6. Tighten the two bolts that hold the brake assembly in place.

Flywheel

There are two types of flywheels available for the MTD engine. An aluminum flywheel and a 3-piece cast iron flywheel. See Figure 7.22.

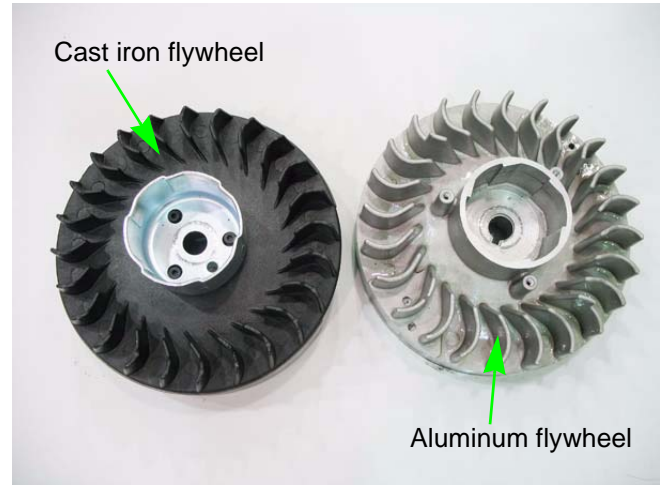

Figure 7.22

NOTE: The procedure for removing the flywheel is the same for both aluminum and cast iron flywheels.

To remove the flywheel:

1. Remove the recoil assembly by following the steps described in Chapter 6: Starter.
2. Lift the fan shroud off of the three studs that locate it. See Figure 7.23.

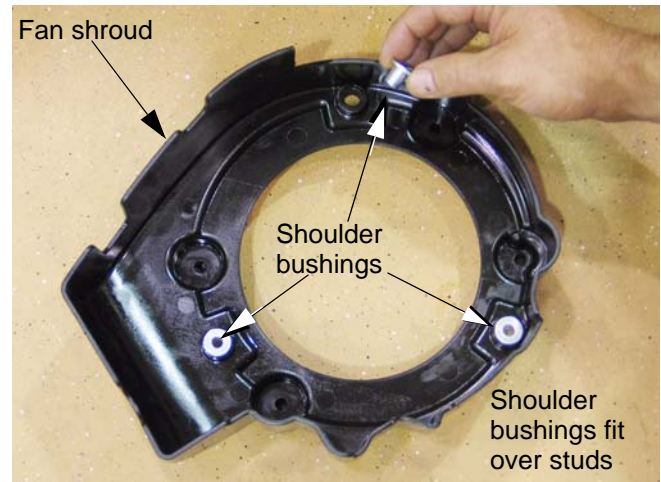

Figure 7.23

Chapter 7: Ignition System

- 2a. Loosen the flywheel nut until it is a couple of threads past the end of the crank shaft using a 19mm wrench. See Figure 7.24.



Figure 7.24

NOTE: If equipped with an engine brake, clamp off the brake using a spring clamp. See Figure 7.25.



Figure 7.25

- 2b. Remove the flywheel by applying a sharp blow to the crankshaft using a brass drift punch and a hammer while gently prying with a prybar. The flywheel will “pop” loose then lift it off.

NOTE: Never strike the crankshaft directly with a hammer. To prevent damage to the crankshaft use a brass drift punch or a piece of wood between the hammer and the crankshaft. See Figure 7.26.

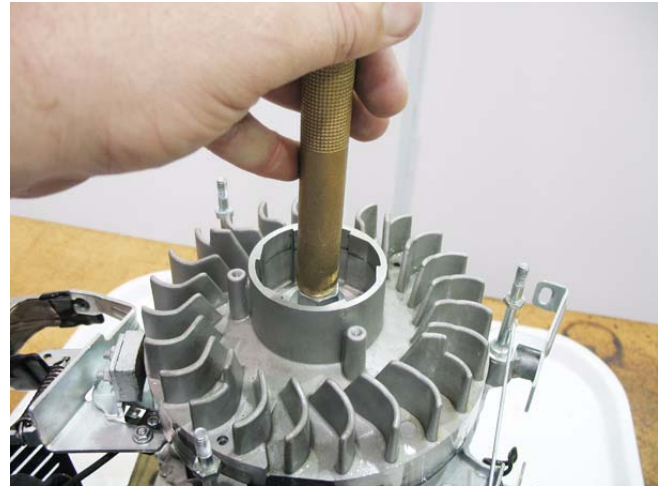

Figure 7.26

CAUTION: If the flywheel shows any signs of physical damage such as cracks, broken vanes, or damaged key-way, replace it. A damaged flywheel poses a threat of burst failure. Burst failures are extremely hazardous to surrounding people and property.

Chapter 7: Ignition System

- 2c. Inspect the key, keyway, and tapered mating surfaces of the flywheel and crankshaft. See Figure 7.27.

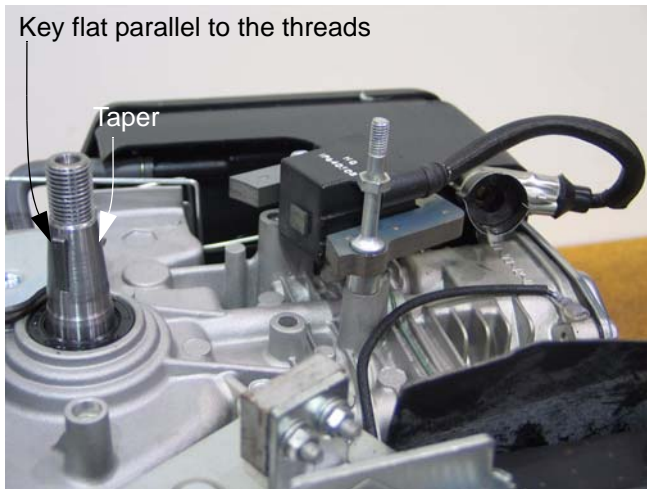

Figure 7.27

NOTE: If the key is damaged it must be replaced. If there is damage to the crankshaft key way, the engine must be short blocked because crankshafts are not available as a service part.

- 2d. On installation, confirm that the key is properly seated (the flat of the key parallel with the threaded section of the crankshaft) in the key-way, and that the tapers are fully seated. Key or keyway failure may result from improper seating.

IMPORTANT: The taper in flywheel and the on the crankshaft must be clean and dry. The flywheel is held in place by the friction fit between the flywheel and the crankshaft, not the key. The key is only to guide the flywheel to the proper position until it is torqued down.

- 2e. Install the flywheel nut to a torque of 47-52 ft-lbs. (64-70 Nm).

NOTE: If the engine has a cast iron flywheel; install a starter cup by placing the starter cup on the flywheel. Allow the protrusion on the bottom of the starter cup to rest inside the dimple in the flywheel with the plastic fan trapped in between the two. See Figure 6.28.

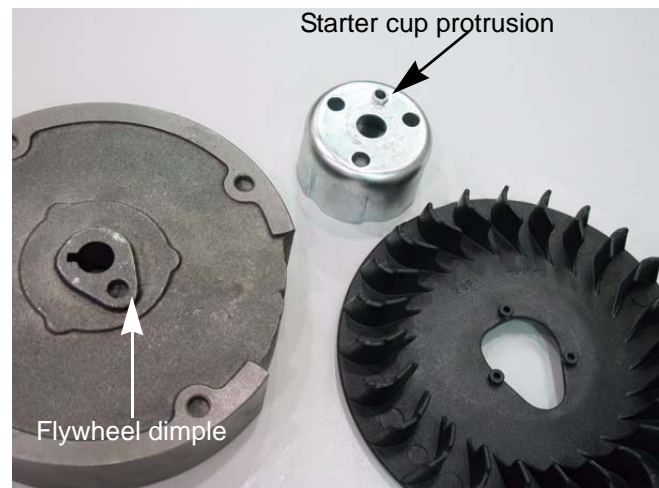

Figure 6.28

- 2f. Adjust the air gap by following the steps described in the previous section of this chapter.
- 2g. Reassemble the engine.
- 2h. Test run the engine before returning to service.

CHAPTER 8: EXHAUST

The exhaust system is a frequently overlooked component of an engine. It is important to make sure the muffler is in good condition and free of debris and/or insects.

NOTE: A blocked muffler will result in poor performance. If a muffler is completely blocked the engine may not start.

The MTD engine uses one of two different mufflers; a standard muffler covered here or a catalytic converter muffler that will be covered later in this chapter.

To remove/replace the conventional muffler

1. Remove the muffler cover that is secured to the cylinder head by removing the two nuts using a 10mm wrench. See Figure 8.1.



Figure 8.1

2. Slide the muffler off of the studs. See Figure 8.2.



Figure 8.2

NOTE: The muffler gasket extends well beyond the port, to act as a heat shield and guides cooling air between the muffler and the cylinder. See Figure 8.3.

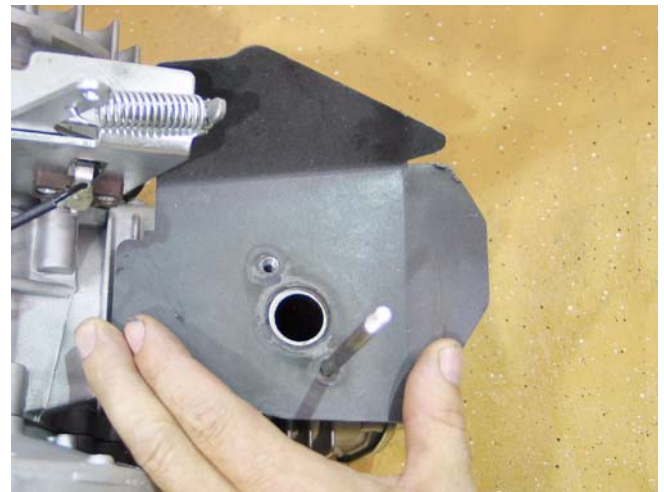

Figure 8.3

NOTE: The exhaust gasket is made of a graphite material. It will stick to the sealing surfaces when pressure is applied, tearing when pressure is relieved. The gasket can only be used one time.

Chapter 8: Exhaust

3. Clean the cylinder head and muffler of any residual gasket material.
4. Using a new gasket, install the muffler by following the above steps in reverse order.

NOTE: Tighten the muffler nuts to a torque of 84 in-lbs (10Nm).

5. Test run the engine before returning to service.

Catalytic converter muffler

The CARB (California) compliant engines use a catalytic converter muffler. This muffler also has an air injector to help with the catalytic reaction in the muffler. The Catalytic muffler can be identified by the presence of this air injector. See Figure 8.4.



Figure 8.4

NOTE: The catalytic converter muffler is removed/replaced by following the same procedures as the conventional muffler.

The catalytic converter is most efficient when it receives the exhaust of an engine running slightly above the stoichiometric point. The catalytic converter breaks down the exhaust, through chemical reactions, to reduce the nitrogen oxide, carbon monoxide and the hydrocarbon emissions. The air injector adds oxygen to the converter so that it can complete its chemical reaction inside the muffler.

NOTE: Stoichiometric point is defined as the point where the mass ratio of fuel to air is chemically balanced. For gasoline, the stoichiometric point is approximately 14.7 to 1.

The air injector works as follows:

- Between the exhaust pulses of the engine, there is low pressure in the exhaust.
- During these periods of low pressure, air is drawn in to the converter through a reed valve in the air injector. See Figure 8.5.

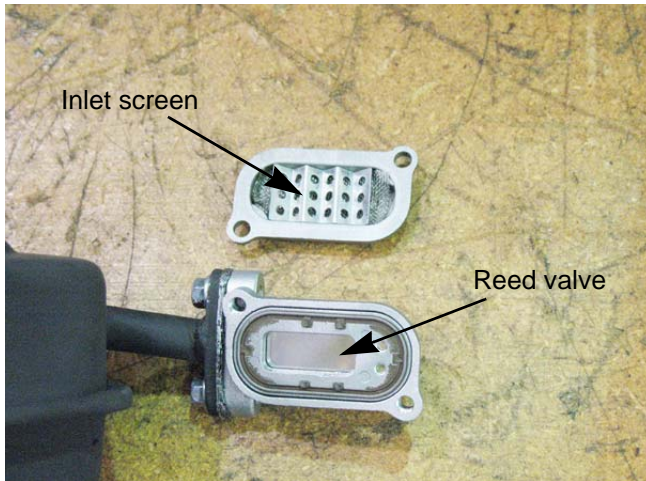

Figure 8.5

- This air provides the oxygen needed for the catalyst to process the next power pulse.
- The reed valve also stops the exhaust from bypassing the catalytic converter and escaping through the air injector.

The air injector has an inlet screen. This screen acts as a filter to keep debris from entering the converter, should this screen become blocked, the converter will not function properly.

To service/replace the air injector:

1. Remove the two screws that secure the air injector using an 8mm wrench. See Figure 8.6.



Figure 8.6

2. Remove the two screws that secure the screen cover using a #2 Phillips screw driver. See Figure 8.7.

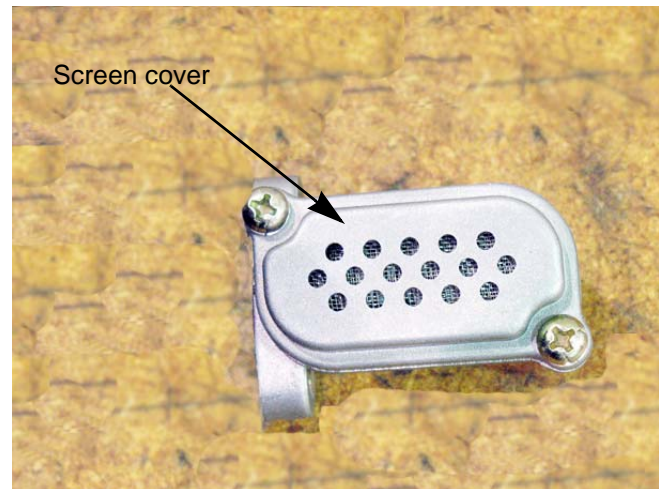

Figure 8.7

NOTE: If the inlet screen is blocked, it may be:

- Replaced
- Cleaned by mechanical means
- Solvent cleaned
- Burned clean using a butane or propane torch.

Chapter 8: Exhaust

3. Install the inlet screen cover and tighten the screws to a torque of 44 in lbs (5 Nm).
4. Clean the gasket material from the air injector and the muffler. See Figure 8.8.

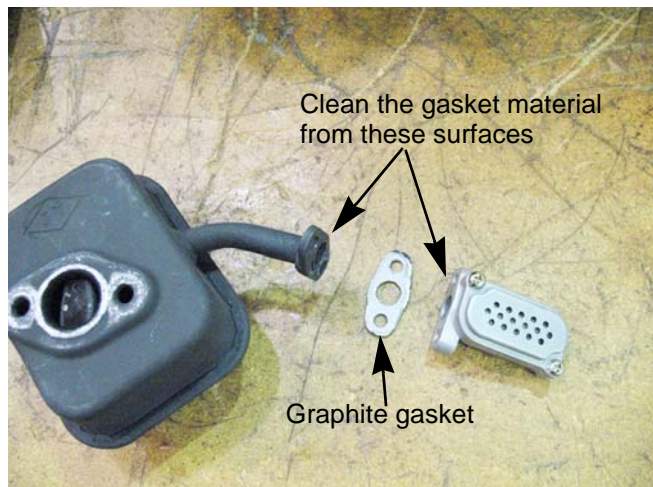

Figure 8.8

NOTE: The air injector has a graphite gasket. It is not reusable. a new gasket must be used every time.

5. Install the air injector and tighten the screws to a torque of 62 in lbs (7 Nm).
6. Test run the engine before returning to service.

CHAPTER 9: CYLINDER HEAD

The Cylinder head of the MTD engine can be removed without removing the engine from the application.

To remove the cylinder head:

NOTE: If possible, It is recommended that the machine be positioned on the bench so that the cylinder head is vertical for removal. See Figure 9.1.



Figure 9.1

NOTE: This position provides easy access to most service points, yet prevents undue oil spillage.

NOTE: Do not store the engine in this position for a long period of time. The oil will seep into the breather chamber.

NOTE: It is not absolutely essential to remove the fan shroud, but taking the engine cover off, if equipped, will ease access to some components.

1. Disconnect and ground the spark plug high tension lead.

2. Remove the spark plug using a 13/16" or 21mm wrench. See Figure 9.2.

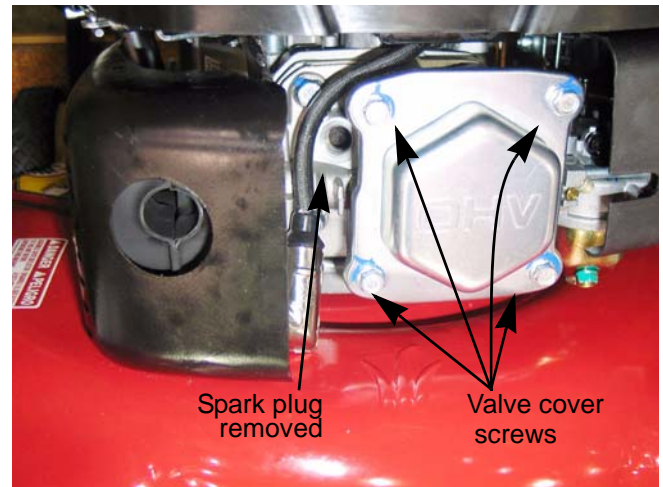

Figure 9.2

3. Rotate the crankshaft until it is at TDC of the compression stroke by following the steps described in the valve lash section of Chapter 1: Introduction.
4. Remove the four screws securing the valve cover using a 10mm wrench. See Figure 9.2.
5. Loosen the jam nuts and fulcrum nuts that secure the rocker arms using a 10mm wrench and a 14mm wrench. See Figure 9.3.

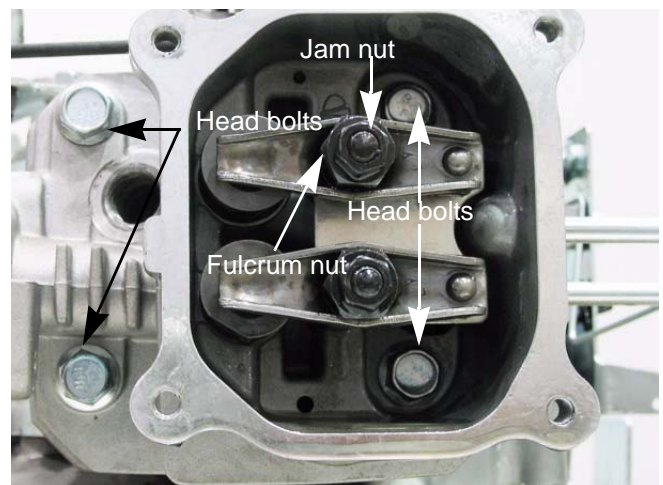

Figure 9.3

Chapter 9: Cylinder Head

- Pivot the rocker arms aside, or remove them completely, and remove the push rods.

NOTE: Once broken-in, the rocker arm should be kept with its corresponding valve.

NOTE: The intake and exhaust push rods are identical and interchangeable. It is preferable, but not absolutely necessary to return the same push rods to their original locations on engine with substantial (≥ 100 hours) operating time.

- Remove the muffler, by following the steps described in Chapter 8: Exhaust.
- Double-nut and remove the exhaust studs, using the same method described in Chapter 3: Air Intake and Filters.
- Remove the carburetor as described in Chapter 3: Air Intake and Filters.
- Remove the cylinder head bolts using a 14mm wrench. See Figure 9.4.

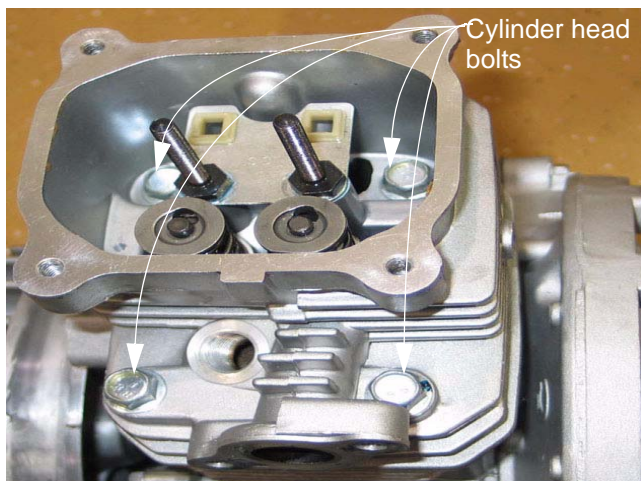

Figure 9.4

- Lift the cylinder head off of the engine.

NOTE: Early production had the alignment dowels fit in the head bolt holes next to the push rod chamber. See Figure 9.5.

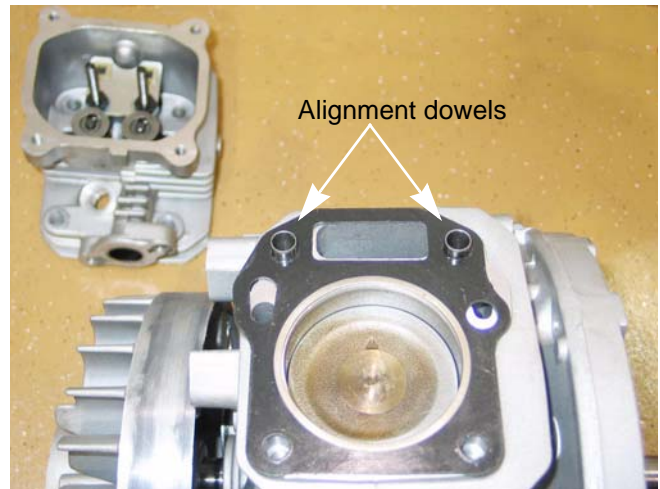

Figure 9.5

NOTE: Current production has the dowels on a diagonal. See Figure 9.6.



Figure 9.6

- Carefully clean all sealing surfaces of all gasket residue. Do not scratch the sealing surfaces.

NOTE: Make a visual inspection of the valves and cylinder bore to confirm the initial diagnosis.

- Place a new head gasket on the cylinder, allowing the alignment dowels to hold it in place.

NOTE: Early production used siliconized head gasket. Current production uses a graphite gasket and it is a direct replacement for the older head gasket. The graphite gasket is a one time use only gasket and must be replaced any time the cylinder head bolts are loosened.

- Position the cylinder head on the engine block.

- Install the 4 head bolts, and tighten them to a step torque of 212 in-lb. (24 Nm) in an alternating diagonal pattern. See Figure 9.7.

NOTE: The bolt closest to the exhaust valve must be the last bolt tightened. Failure to do so will result in the head bolt loosening up.

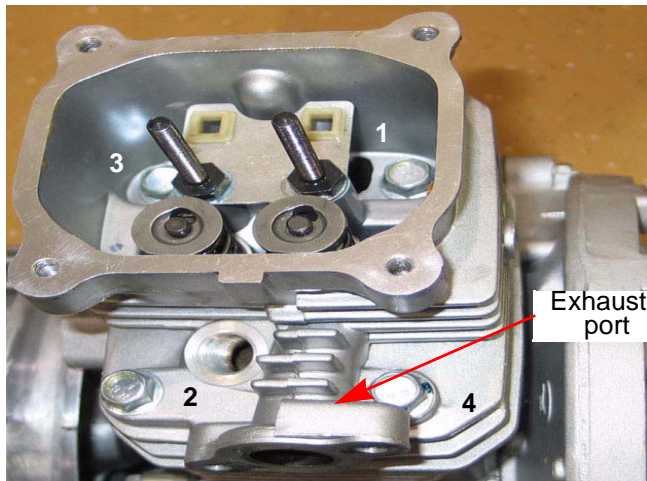

Figure 9.7

- Insert the push rods.
- Install the rocker arms. Adjust the valve lash by following the steps described in Chapter 1: Introduction.
- Install the carburetor and air cleaner, using new gaskets, by following the steps described in Chapter 3: Air Intake
- Install the muffler by following the steps described in Chapter 8: Exhaust.
- Test run the mower in a safe area before returning it to service. Check all safety features.

Valves

Valves and valve parts, like springs and keepers, are not available as service parts. The valves and valve seats can be serviced by grinding and lapping or the head can be replaced. Depending on local machine and labor costs, it is probably more economical to replace the cylinder head versus servicing the valves.

To service the valves:

NOTE: Servicing valves during the warranty period will void the warranty. Warranty valve repairs are to be accomplished by replacing the cylinder head.

- Remove the cylinder head by following the steps described earlier in this chapter.
- Remove the rocker arms by:
 - Remove the jam nuts.
 - Remove the fulcrum nut.
 - Slide the rocker arms off of the rocker studs.
- Remove the valve retainers by applying light finger pressure on the valve retainers and sliding them forward. See Figure 9.8.

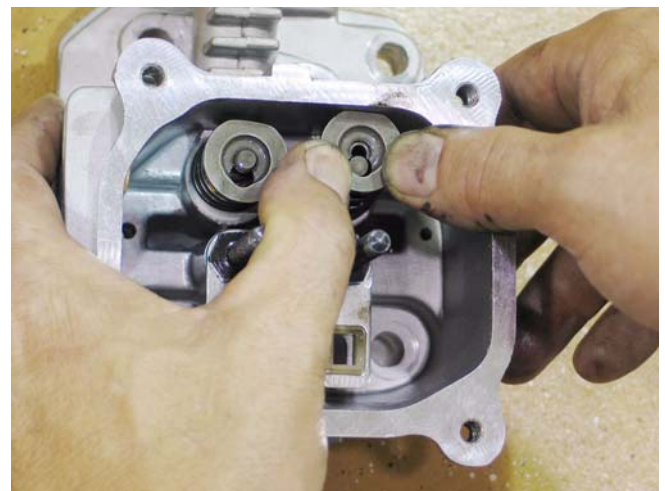

Figure 9.8

- Lift the springs off of the valve stems.
- Slide the valves out of the cylinder head.

Chapter 9: Cylinder Head

NOTE: Only the intake valve has a valve guide seal. See Figure 9.9.

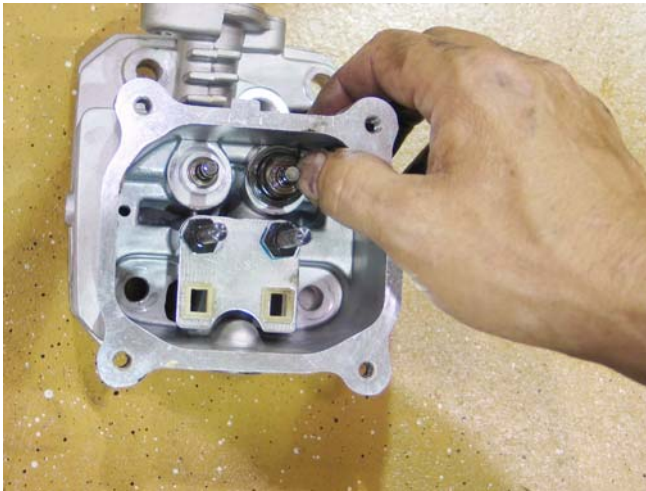

Figure 9.9

6. Inspect the valve seat. See Figure 9.10.

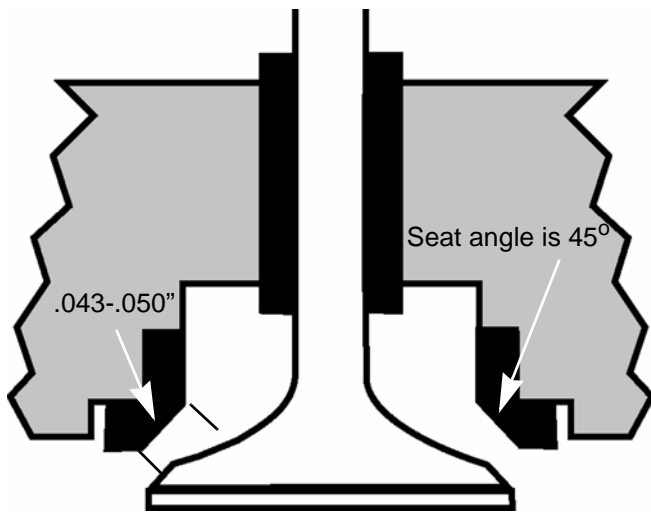

Figure 9.10

- Valve seats are 45 degrees, with a 15 degree topping cut and a 75 degree narrowing cut.
- Seat width should be .043"-.050" (1.1-1.3mm) with a margin of .024" (.6mm) on the exhaust valve and .027" (.7mm) on the intake valve.

NOTE: The valve seat can be ground to clean it up as long as the finished seat is within the tolerances listed above.

7. Inspect the valve stem. See Figure 9.11.

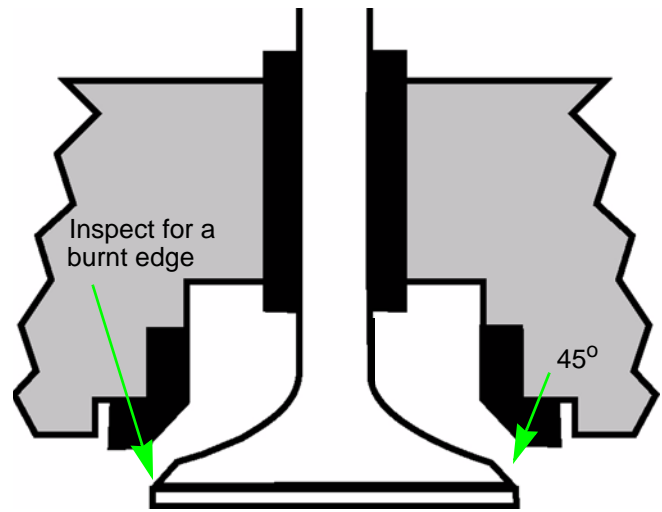

Figure 9.11

8. Inspect the valve springs.

NOTE: Valve spring free length should be at least 1.22" (28.5mm). Original length is 1.44" (36.6mm).

9. Install the valves in the cylinder head by following steps 2 - 5 in reverse order.
10. Test the valves for leaks by:
 - 10a. Place the cylinder head on a couple of wood blocks with the valves facing up.
 - 10b. Pour a small amount of gasoline or parts cleaning solvent into the combustion chamber (just enough to cover the valves).
 - 10c. Let the cylinder head sit for ten minutes.
 - 10d. Check for gasoline leaking out of the intake and exhaust ports.
11. Install the cylinder head by following the steps described earlier in this chapter.
12. Set the valve lash by following the steps described in Chapter 1: Introduction.

CHAPTER 10: CRANKSHAFT, PISTON AND CONNECTING ROD

There are a few different paths that can be followed when disassembling an engine. This chapter will cover the removal of components in one order, but it is written so that the technician can jump around to the component being removed.

The first step to disassemble the engine is to remove the engine from the application by following the steps described in the service manual for that particular application.

NOTE: The MTD engine is NOT to be opened under warranty. If an internal engine failure occurs during the warranty period, replace the whole engine, no short blocks.

1. Drain and save the oil from the engine by following the steps described in Chapter 1: Introduction.
2. Remove the fuel tank by following the steps described in Chapter 4: Fuel system and Governor.
3. Remove the starter by following the steps described in Chapter 6: Starter systems.
4. Remove the flywheel and ignition module by following the steps described in Chapter 7: Ignition system.
5. Remove the muffler by following the steps described in Chapter 8: Exhaust.
NOTE: At this point it would be a good idea to service the PCV valve by following the steps described in Chapter 5: Lubrication.
6. Remove the cylinder head by following the steps described in Chapter 9: Cylinder head.
7. Clean the cylinder bore and remove all carbon.
8. Turn the engine over.
9. Remove the sump bolts using a 10mm wrench on the 1P61/65 and a 12mm wrench on the 1P70.

10. Carefully slide the sump off of the crank shaft. See Figure 10.1.

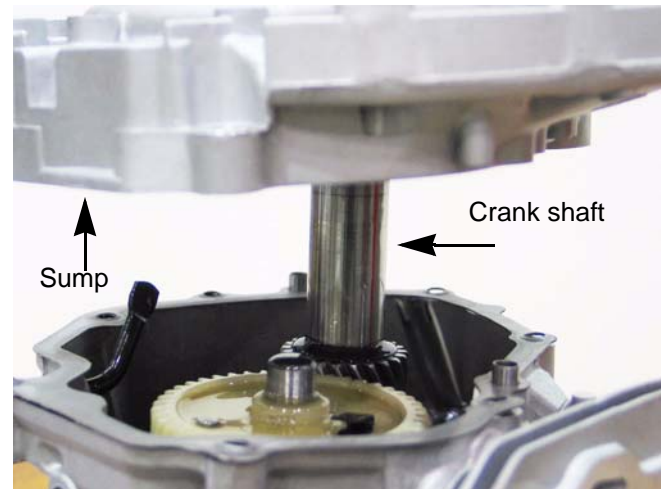

Figure 10.1

NOTE: The thrust washer should be removed when the sump is removed.

11. Remove the camshaft. See Figure 10.2.

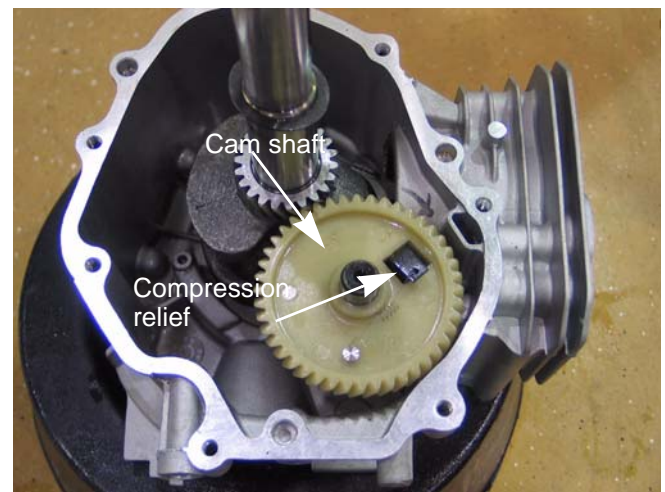

Figure 10.2

NOTE: Align the timing marks to allow easier removal of the cam shaft and to help protect the compression relief from damage.

Chapter 10: Crankshaft, piston and Connecting Rod

NOTE: Early production of the 1P70 series engines had a steel cam shaft. See Figure 10.3.

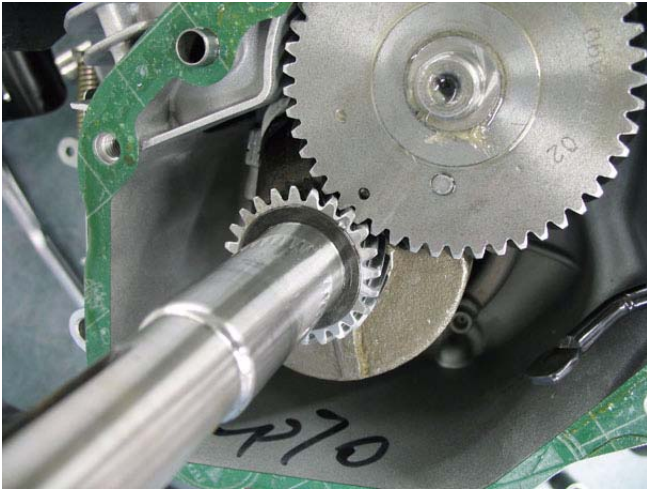

Figure 10.3

12. Remove the valve tappets. See Figure 10.4.

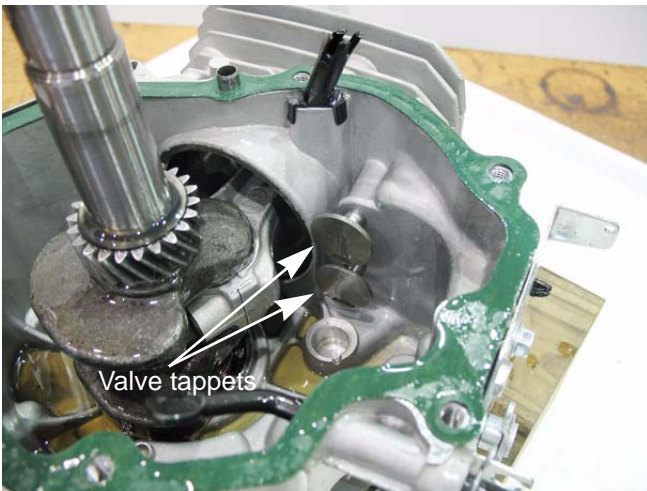

Figure 10.4

13. Remove the connecting rod cap using a 10mm wrench. See Figure 10.5.

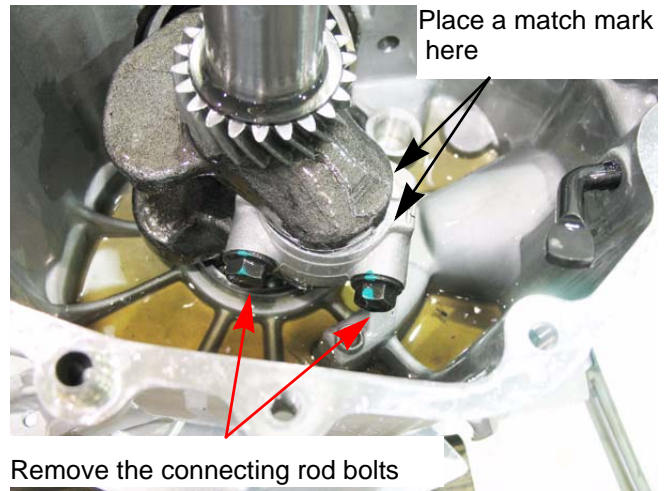

Figure 10.5

NOTE: Match mark the connecting rod cap and the connecting rod so that they can be reassembled in the proper orientation.

NOTE: Rotating the crank shaft after the connecting rod bolts are removed will help to separate the connecting rod from the cap. See Figure 10.6.

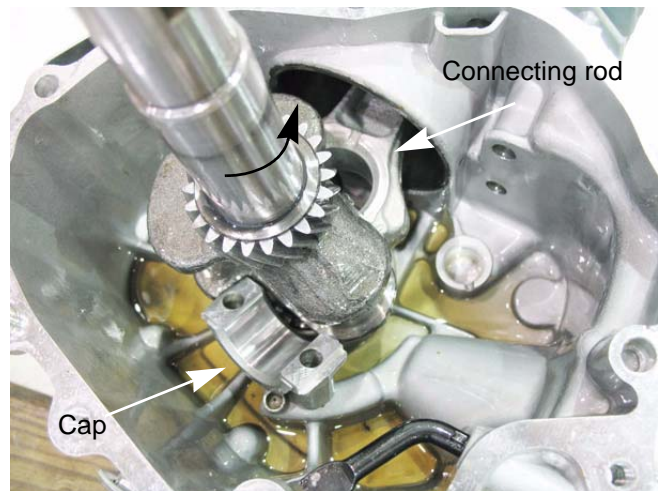

Figure 10.6

Chapter 10: Crankshaft, piston and Connecting Rod

14. Push the piston out of the cylinder.
15. Remove the piston rings from the piston using a pair of piston ring pliers. See Figure 10.7.



Figure 10.7

16. Remove the crank shaft. See Figure 10.8.

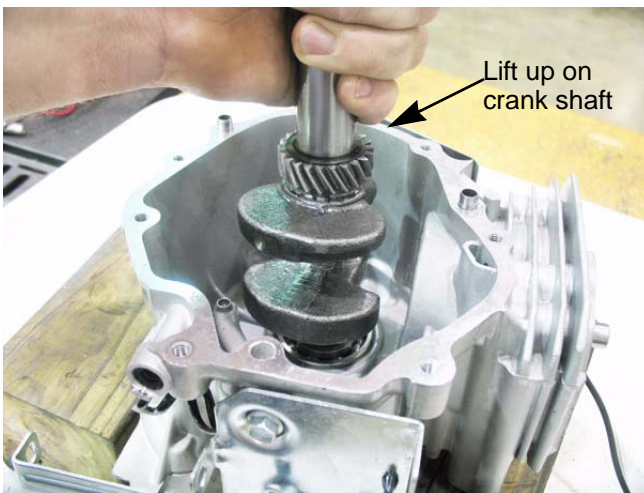

Figure 10.8

The internal components of the MTD engine are not available as service parts. The intent of this chapter is to provide the technician the procedures to examine an engine and to provide the specification to determine if an engine is worn out. All of the specifications are listed in a chart at the end of the chapter.

Crank shaft inspection

1. Inspect the crank shaft journals for galling, scoring, pitting or any other form of damage.
2. Measure the journals at the bearing contact points using a vernier caliper or a micrometer. See Figure 10.9.



Figure 10.9

3. Inspect the crankpin for galling, scoring, pitting or any other form of damage.

Chapter 10: Crankshaft, piston and Connecting Rod

4. Measure the crankpin using a vernier caliper or a micrometer. See Figure 10.10.



Figure 10.10

5. Check the crank shaft for straightness by measuring the run out. The crank shaft run out can be checked by:
 - 5a. Place the crank shaft on a pair of matched V-blocks or in the engine block with the sump installed.
 - 5b. Place a dial indicator at a smooth point at either end of the crank shaft.
 - 5c. Slowly turn the crank shaft while watching the dial indicator.

NOTE: Stop the crank shaft before the dial indicator hits the keyway.

 - 5d. Compare the reading on the dial indicator to the specification listed at the end of this chapter.
 - 5e. Repeat the above steps on the other end of the crank shaft.

Piston Inspection

1. Clean the piston and remove all carbon from the rings and ring grooves.
2. Insert one ring into the cylinder. Push it down about one inch from the top. See Figure 10.11.



Figure 10.11

3. Measure the end gap with a feeler gauge and compare to the chart at the end of this chapter. See Figure 10.11.
 4. Repeat steps 3 and 4 on the other rings.
- NOTE:** Piston rings are not available as service parts. If any of the end gaps are out of spec, the engine must be short blocked.
5. Install rings back onto the piston. See Figure 10.12.



Figure 10.12

Chapter 10: Crankshaft, piston and Connecting Rod

NOTE: The top ring is symmetrical and the middle ring has a tapered profile. The larger radius of the middle ring should face the crankshaft. See Figure 10.13.

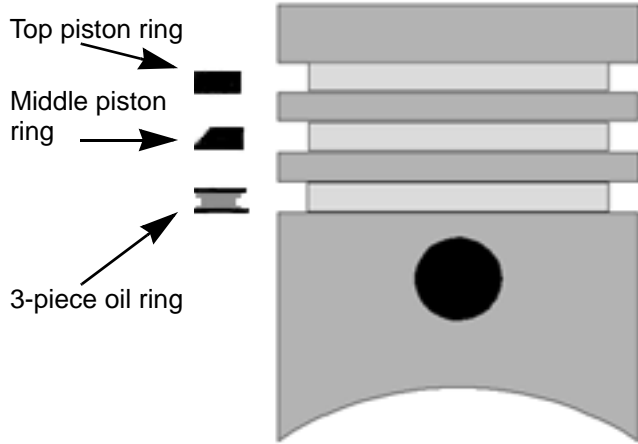

Figure 10.13

6. Measure the distance between the ring and the ring land using a feeler gauge and compare the measurement to the chart at the end of this chapter. See Figure 10.14.



Figure 10.14

Connecting rod inspection

1. Inspect the connecting rod for cracks or any signs of damage.
2. Install the rod cap and tighten to a torque of 102 -111 in-lbs (11.5-12.5 Nm)
3. Measure the inside diameter of the connecting rod and compare the measurements to those listed in the chart at the end of this chapter. See Figure 10.15.

NOTE: Take two measurements 90 degrees apart. This will check the out of roundness of the connecting rod.



Figure 10.15

NOTE: Connecting rods are not available as service parts. If the connecting rod is bad, the engine must be short blocked.

4. Take the crankshaft journal measurement and subtract it from the connecting rod measurement to get the connecting rod to journal running clearance. Compare that number to the one listed in the chart at the end of this chapter.

Chapter 10: Crankshaft, piston and Connecting Rod

Cylinder inspection

1. Clean and inspect the cylinder, inside and out.

NOTE: If there is any sign of damage, especially cracked cooling fins, short block the engine.

NOTE: Take two measurements of the cylinder bore 90 degrees apart at the top, bottom and middle of the cylinder. See Figure 10.16.

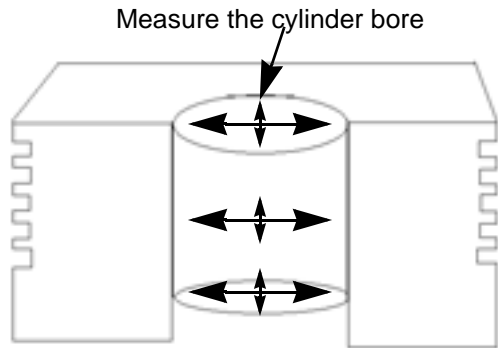

Figure 10.16

NOTE: The measurements can be made using telescoping gauges, inside micrometers or a cylinder bore dial indicator. See Figure 10.17.

Measuring the cylinder bore using a cylinder bore dial indicator



Figure 10.17

2. Compare the measurements to those that are listed in the chart at the end of the chapter.
3. Inspect the cylinder cross hatch. See Figure 10.18.

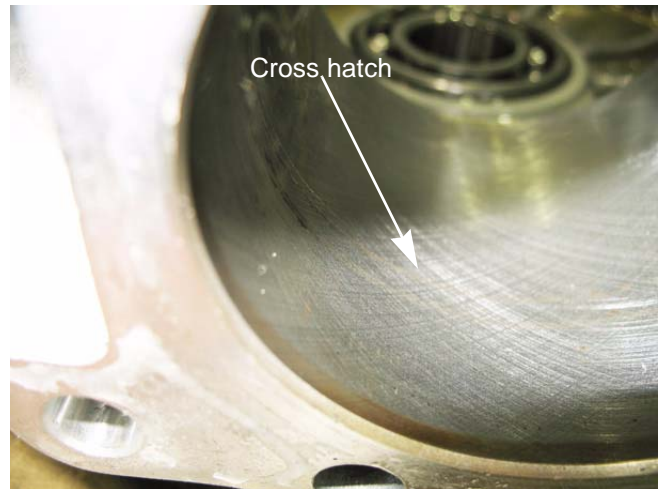

Figure 10.18

NOTE: The cross hatch is important because it helps hold oil on the cylinder walls.

NOTE: If the cross hatch is polished off, that is a sign of dirt ingestion. The cylinder can not be re-honed because replacement piston rings are not available. The engine must be short blocked.

Chapter 10: Crankshaft, piston and Connecting Rod

Bearings

There are two bearings to inspect; a plain bearing in the sump and a ball bearing in the cylinder block. To inspect the bearings:

1. Remove the sump and cylinder block oil seals using a seal puller. See Figure 10.19.

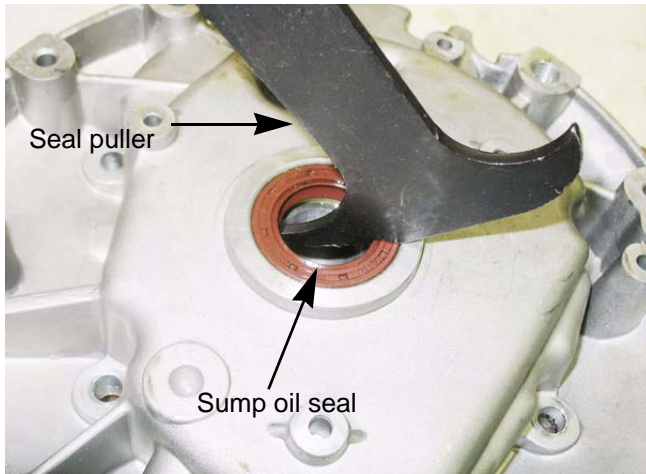

Figure 10.19

2. Inspect the bearing surface for galling, scratches, metal transfer or any other signs of damage.
3. Measure the inside diameter of the bearings and compare to the chart at the end of this chapter. See Figure 10.20.

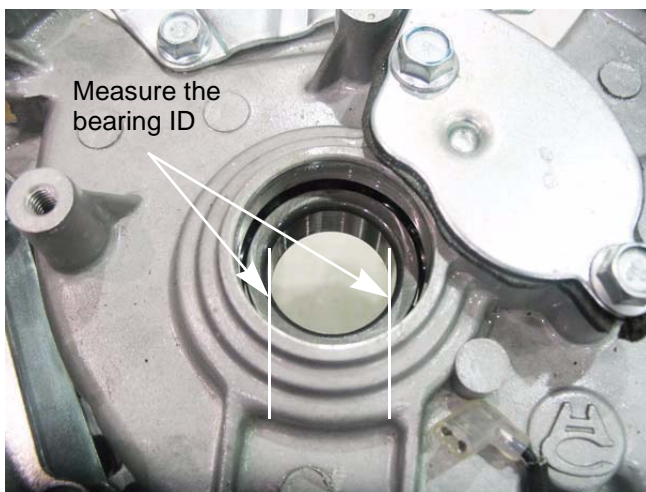

Figure 10.20

NOTE: The bearing can not be serviced. If they are bad the engine must be short blocked.

Reassembly

1. Clean the cylinder
 - 1a. Remove all gasket material from all mating surfaces.
 - 1b. Clean the cylinder and sump.
2. Oil seals
 - 2a. Install a new oil seal in the cylinder block.
NOTE: A piece of 1" schedule 40 PVC pipe can be used as a seal driver.
 - 2b. Install a new seal in the sump.
See Figure 10.21.

NOTE: Use a Troy-Bilt tiller seal service tool # TWX-4006 to install the sump oil seal.

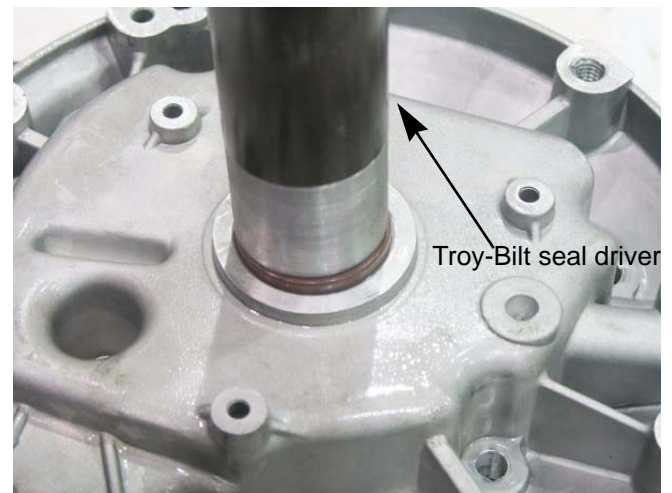

Figure 10.21

Chapter 10: Crankshaft, piston and Connecting Rod

3. Insert the crankshaft into the cylinder block bearing.

NOTE: Pre-lube the crank shaft with clean 10W-30 motor oil or engine assembly lube.

NOTE: Use an old piece of microfiche or a seal protector to protect the oil seal lip while inserting the crank shaft. See Figure 10.22.



Figure 10.22

4. Install the piston by:
 - 4a. Compress the piston rings using a piston ring compressor.
 - 4b. Pre-lube the cylinder wall with clean 10W-30 motor oil
 - 4c. Slide the connecting rod and piston into the cylinder.

NOTE: The arrow on the piston must point towards the push rod cavity. See Figure 10.23.

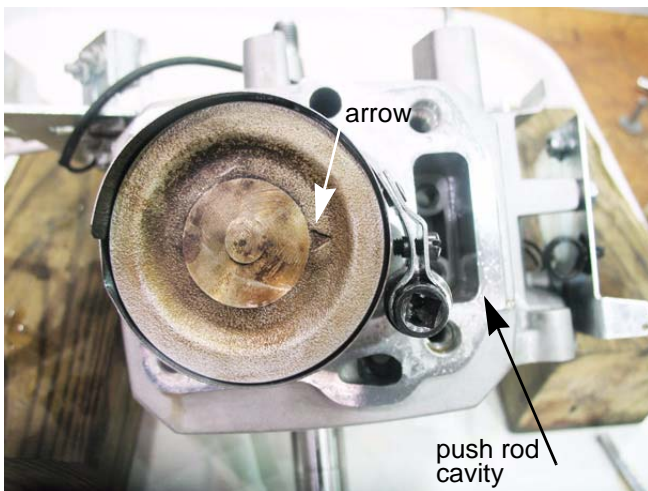

Figure 10.23

- 4d. Tap the piston through the ring compressor into the cylinder using a wooden hammer handle. See Figure 10.24.

NOTE: Make sure the crankshaft journal is at BDC (bottom dead center) to prevent damage from the connecting rod.



Figure 10.24

- 4e. Pre-lube the connecting rod with clean 10W-30 motor oil or engine assembly lube.
- 4f. Install the connecting rod cap. Apply a small amount of releasable thread locking compound such as Loctite® 242 (blue) to the connecting rod bolts and tighten the cap bolts to a torque of 102 - 111 in-lbs (11.5 - 12.5 Nm). See Figure 10.25.

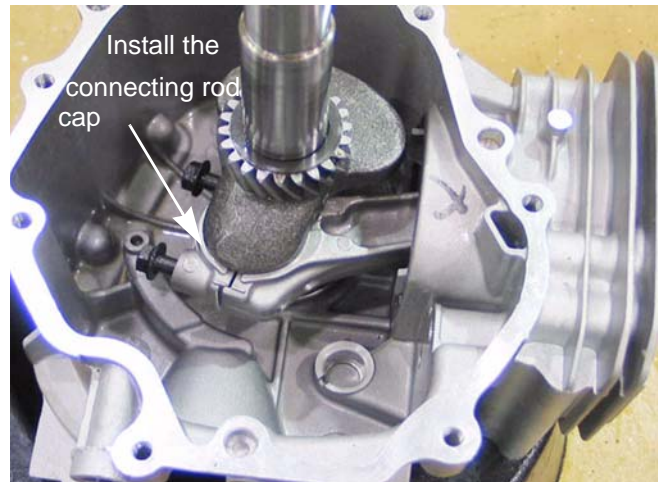

Figure 10.25

Chapter 10: Crankshaft, piston and Connecting Rod

5. Install the valve tappets. See Figure 10.26.

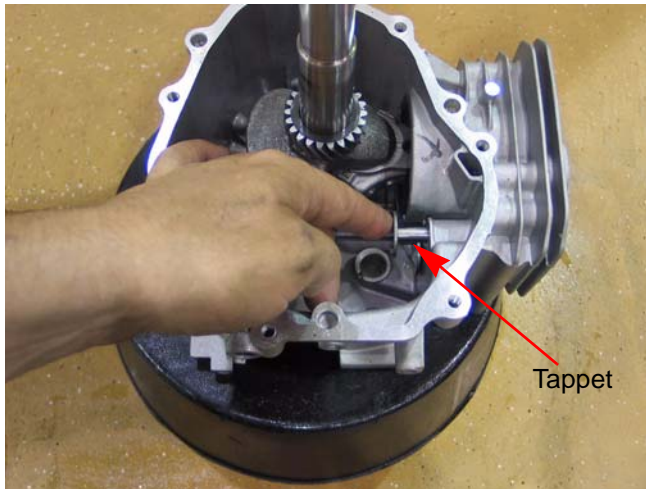

Figure 10.26

6. Install the cam shaft by:
- 6a. Pre-lube the cam shaft with clean 10W-30 motor oil or engine assembly lube.
 - 6b. Rotate the crank shaft until the timing mark points to the tappets.
 - 6c. Insert the cam shaft while aligning the timing marks. See Figure 10.27.

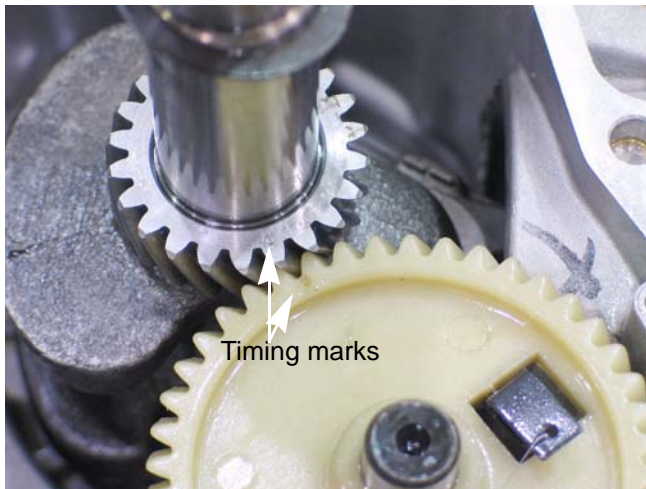

Figure 10.27

7. If removed, install the governor arm by following the steps described in Chapter 4: Fuel systems and Governor.
8. If removed, install the oil return deflector. See Figure 10.28.

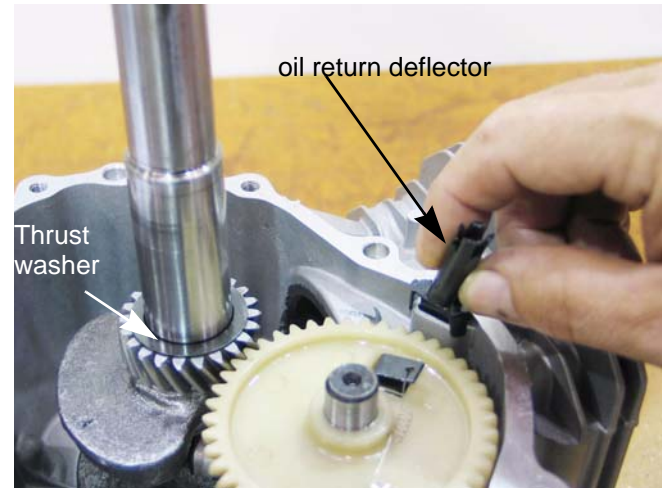

Figure 10.28

9. Place the thrust washer on the crank shaft. See Figure 10.28.
10. Install the sump by:
- 10a. If removed, install the governor gear and cup by following the steps described in Chapter 4: Fuel system and Governor.
 - 10b. Place a new gasket on the sump, let the alignment dowels hold it in place.
 - 10c. Rotate the governor arm so that it is pointing straight up.

Chapter 10: Crankshaft, piston and Connecting Rod

10d. Using a seal protector, slide the sump on to the crank shaft.

NOTE: The governor arm must slide between the governor cup and the governor arm stop. See Figure 10.29.

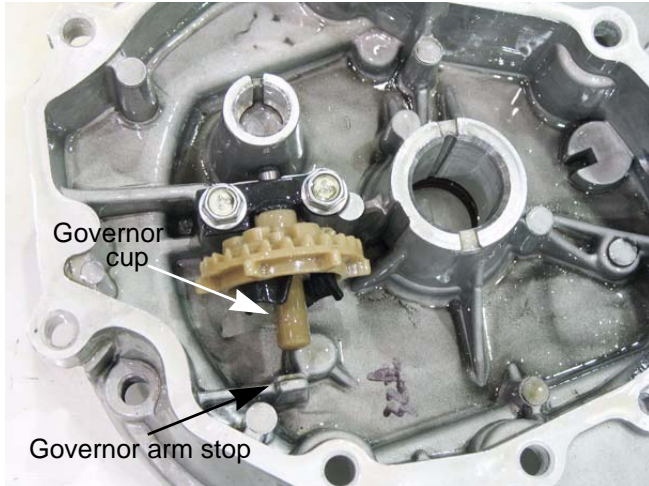

Figure 10.29

NOTE: Watch the governor arm as the sump is slid into place. Rotate the arm as needed to allow the arm to slip into place. See Figure 10.30.

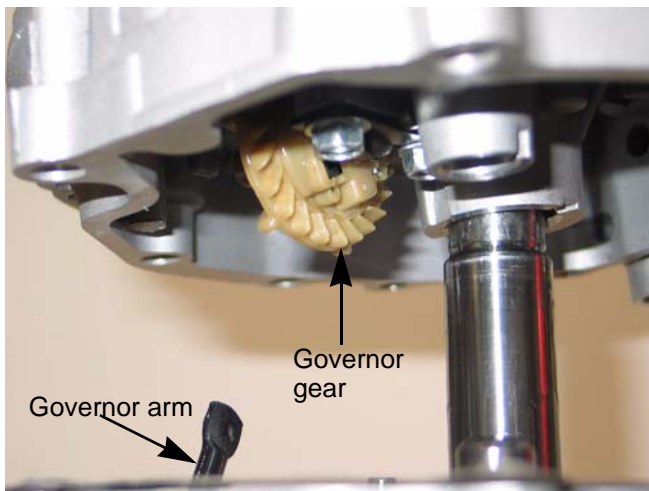

Figure 10.30

10e. Rock sump until it seats fully against the cylinder block.

10f. Install the sump bolts and tighten to a torque of 89 in-lbs (10 Nm).

NOTE: Use a star torque pattern to tighten the sump bolts.

11. Install the cylinder head by following the steps described in Chapter 9: Cylinder head.
12. Install the muffler by following the steps described in Chapter 8: Exhaust.
13. Install the fuel tank by following the steps described in Chapter 4: Fuel systems and Governor.
14. Install the carburetor by following the steps described in Chapter 3: Air Intake and Filters.
15. Install the flywheel and module by following the steps described in Chapter 7: Ignition system.
NOTE: If equipped, install the engine brake by following the steps described in the application's service manual.
16. Install the blower housing and starter by following the steps described in Chapter 6: Starter.
17. Install the engine on the application by following the steps described in the application's service manual.
18. Install the spark plug by following the steps described in Chapter 7: Ignition system.
19. Fill the engine with oil and fuel by following the steps described in Chapter 1: Introduction.
20. Test run the engine in a safe area and make any carburetor and governor adjustments needed.

Chapter 10: Crankshaft, piston and Connecting Rod

Engine specifications chart

	New min		New max		service limit	
	Inch	Metric (mm)	Inch	Metric (mm)	Inch	Metric (mm)
Displacement						
1P61			122.7 cc (7.5 ^{^3})			
1P65			139.4 cc(8.5 ^{^3})			
1P70			173.2 cc (10.6^{^3})			
Bore (new)						
1P61	2.402	61.00	2.403	61.03	2.409	61.18
1P65	2.559	65.00	2.560	65.03	2.567	65.19
1P70	2.756	70.00	2.756	70.02	2.764	70.20
Bore out of round						
1P61	0.000	0.00	0.000	0.01	0.000	0.01
1P65	0.000	0.00	0.000	0.01	0.000	0.01
1P70	0.000	0.00	0.000	0.01	0.000	0.01
Cylinder taper						
1P61	0.000	0.00	0.000	0.01	0.000	0.01
1P65	0.000	0.00	0.000	0.01	0.000	0.01
1P70	0.000	0.00	0.000	0.01	0.000	0.01
Crank journal (flywheel end) diameter						
1P61	0.984	24.98	0.984	24.99	0.979	24.87
1P65	0.984	24.98	0.984	24.99	0.979	24.87
1P70	0.983	24.98	0.984	24.99	0.979	24.87
Crank journal (PTO end) diameter						
1P61	0.983	24.97	0.984	24.99	0.979	24.86
1P65	0.983	24.97	0.984	24.99	0.979	24.86
1P70	0.999	25.37	0.999	25.39	0.995	25.26
Crank pin diameter						
1P61	1.023	25.98	1.023	25.99	1.021	25.94
1P65	1.023	25.98	1.023	25.99	1.021	25.94
1P70	1.181	29.99	1.181	30.00	1.179	29.94
Connecting rod ID (crank side)						
1P61	1.024	26.01	1.024	26.02	1.026	26.06
1P65	1.024	26.01	1.024	26.02	1.026	26.06
1P70	1.182	30.02	1.182	30.02	1.184	30.06
Connecting rod to crank pin running clearance						
1P61	0.001	0.02	0.001	0.04	0.002	0.06
1P65	0.001	0.02	0.001	0.04	0.002	0.06
1P70	0.001	0.02	0.002	0.04	0.002	0.06
Connecting rod to crank pin side clearance						
1P61	0.006	0.15	0.026	0.65	0.049	1.24
1P65	0.006	0.15	0.026	0.65	0.026	0.65
1P70	0.008	0.20	0.020	0.50	0.037	0.95

Chapter 10: Crankshaft, piston and Connecting Rod

	New min		New max		service limit	
	Inch	Metric (mm)	Inch	Metric (mm)	Inch	Metric (mm)
Crank shaft run out						
1P61	0.001	0.03	0.001	0.03	0.000	0.00
1P65	0.001	0.03	0.001	0.03	0.000	0.00
1P70	0.001	0.03	0.001	0.03	0.000	0.00
Crank shaft end play						
1P61	0.011	0.27	0.030	0.75	0.000	0.00
1P65	0.011	0.27	0.030	0.75	0.000	0.00
1P70	0.012	0.30	0.026	0.67	0.000	0.00
Crank shaft bearing ID (cylinder block)						
1P61	0.984	24.99	0.984	25.00	0.000	0.00
1P65	0.984	24.99	0.984	25.00	0.000	0.00
1P70	0.984	24.99	0.984	25.00	0.000	0.00
Crank shaft bearing ID (sump)						
1P61	0.984	25.00	0.985	25.02	0.000	0.00
1P65	0.984	25.00	0.985	25.02	0.000	0.00
1P70	1.000	25.40	1.001	25.42	0.000	0.00
Cam shaft OD (cylinder block)						
1P61	0.547	13.90	0.550	13.97	0.000	0.00
1P65	0.547	13.90	0.550	13.97	0.000	0.00
1P70	0.550	13.97	0.551	13.98	0.000	0.00
Cam shaft OD (sump side)						
1P61	0.547	13.90	0.550	13.97	0.000	0.00
1P65	0.547	13.90	0.550	13.97	0.000	0.00
1P70	0.550	13.97	0.551	13.98	0.000	0.00
Cam shaft bearing ID (cylinder block)						
1P61	0.551	14.00	0.552	14.02	0.000	0.00
1P65	0.551	14.00	0.552	14.02	0.000	0.00
1P70	0.551	14.00	0.552	14.02	0.000	0.00
Cam shaft bearing ID (sump)						
1P61	0.551	14.00	0.552	14.02	0.000	0.00
1P65	0.551	14.00	0.552	14.02	0.000	0.00
1P70	0.551	14.00	0.552	14.02	0.000	0.00
Intake lobe height						
1P61	1.075	27.30	1.091	27.70	0.000	0.00
1P65	1.075	27.30	1.091	27.70	0.000	0.00
1P70	1.079	27.40	1.094	27.80	0.000	0.00
Exhaust lobe height						
1P61	1.083	27.50	1.098	27.90	0.000	0.00
1P65	1.083	27.50	1.098	27.90	0.000	0.00
1P70	1.083	27.50	1.098	27.90	0.000	0.00

Chapter 10: Crankshaft, piston and Connecting Rod

	New min		New max		service limit	
	Inch	Metric (mm)	Inch	Metric (mm)	Inch	Metric (mm)
Compression ring end gap						
1P61	0.006	0.15	0.012	0.30	0.000	0.00
1P65	0.006	0.15	0.012	0.30	0.000	0.00
1P70	0.006	0.15	0.012	0.30	0.000	0.00
Scraper (second) ring end gap						
1P61	0.006	0.15	0.012	0.30	0.000	0.00
1P65	0.006	0.15	0.012	0.30	0.000	0.00
1P70	0.008	0.20	0.016	0.40	0.000	0.00
Compression ring to land clearance						
1P61	0.001	0.03	0.003	0.07	0.000	0.00
1P65	0.001	0.02	0.002	0.06	0.000	0.00
1P70	0.001	0.02	0.002	0.06	0.000	0.00
Scraper ring to land clearance						
1P61	0.000	0.01	0.002	0.05	0.000	0.00
1P65	0.001	0.02	0.002	0.06	0.000	0.00
1P70	0.001	0.02	0.002	0.06	0.000	0.00
Oil ring to land clearance						
1P61	0.001	0.03	0.006	0.15	0.000	0.00
1P65	0.002	0.04	0.006	0.16	0.000	0.00
1P70	0.002	0.04	0.006	0.16	0.000	0.00
Intake valve lash						
1P61	0.003	0.08	0.005	0.12		
1P65	0.003	0.08	0.005	0.12		
1P70	0.003	0.08	0.005	0.12		
Exhaust valve lash						
1P61	0.005	0.13	0.007	0.17		
1P65	0.005	0.13	0.007	0.17		
1P70	0.005	0.13	0.007	0.17		
Spark plug gap						
1P61	0.024	0.60	0.031	0.80		
1P65	0.024	0.60	0.031	0.80		
1P70	0.024	0.60	0.031	0.80		
Module air gap						
1P61	0.008	0.20	0.016	0.40		
1P65	0.008	0.20	0.016	0.40		
1P70	0.008	0.20	0.016	0.40		

Chapter 10: Crankshaft, piston and Connecting Rod

Engine torque values chart

Table 1:

Fastener Torque	1P61	1P65	1P70
Blower housing studs	89 in-lbs (10 Nm)	89 in-lbs (10 Nm)	89 in-lbs (10 Nm)
Breather cover	27 - 35 in-lbs (3 - 4 Nm)	27 - 35 in-lbs (3 - 4 Nm)	27 - 35 in-lbs (3 - 4 Nm)
Carburetor drain bolt	53 - 80 in-lbs (6 - 9 Nm)	53 - 80 in-lbs (6 - 9 Nm)	53 - 80 in-lbs (6 - 9 Nm)
Carburetor mounting nuts	80-106 in-lbs (9-12 Nm)	80-106 in-lbs (9-12 Nm)	80-106 in-lbs (9-12 Nm)
Connecting rod cap bolts	102 -111 in-lbs.* (11.5-12.5 Nm)	102 -111 in-lbs.* (11.5-12.5 Nm)	102 -111 in-lbs.* (11.5-12.5 Nm)
Drain plug	106 - 124 in-lbs (12 - 14 Nm)	106 - 124 in-lbs (12 - 14 Nm)	106 - 124 in-lbs (12 - 14 Nm)
Flywheel nut	48-52 ft-lbs (64-70 Nm)	48-52 ft-lbs (64-70 Nm)	48-52 ft-lbs (64-70 Nm)
Head bolt	20 - 22 ft-lbs step (28 - 30 Nm)	20 - 22 ft-lbs step (28 - 30 Nm)	20 - 22 ft-lbs step (28 - 30 Nm)
Module	80-106 in-lbs (9-12 Nm)	80-106 in-lbs (9-12 Nm)	80-106 in-lbs (9-12 Nm)
Muffler	80-106 in-lbs (9-12 Nm)	80-106 in-lbs (9-12 Nm)	80-106 in-lbs (9-12 Nm)
Rocker jam nut	80-106 in-lbs (9-12 Nm)	80-106 in-lbs (9-12 Nm)	80-106 in-lbs (9-12 Nm)
Rocker stud	16 - 18 ft-lbs (22 - 25 Nm)	16 - 18 ft-lbs (22 - 25 Nm)	16 - 18 ft-lbs (22 - 25 Nm)
Spark plug	15-19 ft-lbs (20-25 Nm)	15-19 ft-lbs (20-25 Nm)	15-19 ft-lbs (20-25 Nm)
Starter	80-106 in-lbs (9-12 Nm)	80-106 in-lbs (9-12 Nm)	80-106 in-lbs (9-12 Nm)
Sump bolts	80-106 in-lbs (9-12 Nm)	80-106 in-lbs (9-12 Nm)	16-18 ft-lbs (22-25 Nm)
Valve cover	62 - 80 in-lbs (7 - 9 Nm)	62 - 80 in-lbs (7 - 9 Nm)	62 - 80 in-lbs (7 - 9 Nm)

NOTE: * - apply a small amount of releasable thread locking compound such as Loctite® 242 (blue).

CHAPTER 11: FAILURE ANALYSIS

A properly maintained engine will provide years of service. Occasionally an engine will fail. An important part of working on engines is finding out why they failed. Was it something the customer did? Was it a manufacturing defect? Did the engine just wear out? All of these questions need to be answered when a failed engine is found.

Engines can fail in a variety of ways but most failures can be classified in the following categories:

- Abrasive ingestion
- Insufficient lubrication
- Over heating
- Over speed
- Mechanical breakage/ wear

NOTE: There may be a combination of failures.

Finding the cause of an engine failure requires the complete disassembly of an engine and careful examination of the parts.

With a good understanding of how the engine works, close examination of the parts and experience, an understanding of why the engine failed can be reached.

Abrasive Ingestion

Abrasive Ingestion is when hard particles are introduced into the engine. Particles can be introduced into the engine by leaks in the air intake system, through a dirty oil fill plug or by particles of metal that wore off of a part, especially during the break in cycle. Particles may also be introduced through worn or improperly installed seals or gaskets.

1. Abrasive particles that enter the engine through the intake system can be sand or dirt. See Figure 11.1.



Figure 11.1

2. An abrasive particle can enter the engine by bypassing an improperly installed air filter, through a bad PCV valve or through leaks in the intake system. Usually there will be tracking marks where the particles enter the system. Use these marks to find the source of the abrasives.

Chapter 11: Failure Analysis

NOTE: Dirt can also work its way through a poorly maintained air filter. See Figure 11.2.



Figure 11.2

3. Particles that enter the intake system travel at great speed and act like sand blasting media inside the engine. This causes wear to the parts affected.

NOTE: Choke and throttle shafts are very vulnerable to this wear. If an air filter becomes clogged, the vacuum produced by the engine will try to draw air in by any means possible. This usually happens around the throttle and choke shafts. Because the throttle shaft moves more than the choke, it will wear faster.

4. The particles can pass through the intake system to the valves and valve seats.
5. When particles enter the combustion chamber, the up and down motion of the piston grinds the particles into the side of the cylinder walls and damages the cylinder wall, piston and piston rings

6. This can be identified by the scoring along the vertical axis of the piston and cylinder wall or the cross hatch on the cylinder wall being worn off.

NOTE: To help in the lubrication of the cylinder walls, and help with the seating of the piston rings, a diamond cross hatch is honed into the cylinder wall. Debris entering the cylinder will polish the cross hatch off of the cylinder wall. See Figure 11.3.



Figure 11.3

NOTE: Abrasives that enter the engine through the intake system will cause the upper portion of the combustion chamber to wear more than the lower portion. Measurements of the cylinder bore at the top and bottom will show this.

Other sources of abrasives that get into the engine includes carbon that builds up on the top side of the piston, metal shavings from the wear of engine parts or dirt entering through the oil fill port. Leaking gaskets and seals also have the potential of allowing debris to enter the engine.

Chapter 11: Failure Analysis

A symptom of abrasive ingestion is smoky exhaust. As the cylinder walls wear; pressure from the combustion chamber blows by the piston and pressurizes the engine sump. This overpowers the PCV valve and allows oil to build up in the combustion chamber. See Figure 11.4.



Figure 11.4

7. Abrasive materials that enter the engine get absorbed by the oil and thicken it. See Figure 11.5.



Figure 11.5

8. Because the oil absorbs the abrasive particles, the engine components that are immersed in oil will show definite signs of abrasive ingestion especially around the connecting rod and main bearing journals. See Figure 11.6.



Figure 11.6

NOTE: Abrasives that are trapped in the oil will cause the lower portion of the combustion chamber to wearing more than the upper portion.

NOTE: Wear of only one bearing surface on a new engine could be a sign of a manufacturing defect.

NOTE: Abrasive particles can also be imbedded into materials that are softer than the abrasive. This will cause the affected part to act like a piece of sand paper or a grinding wheel. See Figure 11.7.

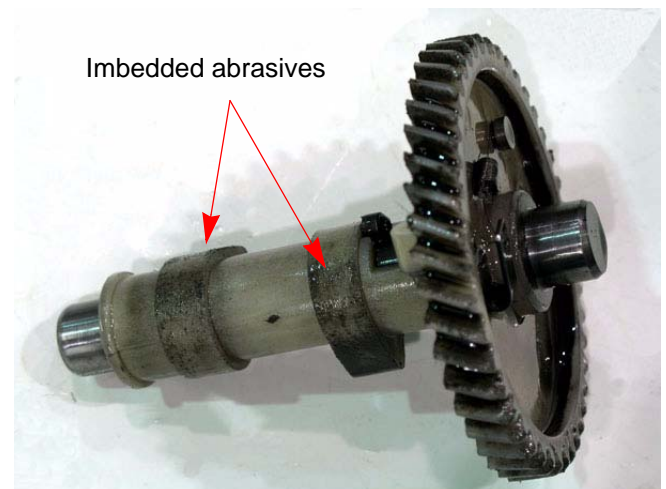

Figure 11.7

Chapter 11: Failure Analysis

Insufficient lubrication

The bearing surfaces in an engine are not smooth. As a result of the machining processes to make the engine parts, there are little peaks and valleys that are only visible on a microscopic scale. These peaks are called asperities. As the engine breaks in, the asperities break off leaving plateaus that become the bearing surface. The valleys become reservoirs for the lubricant.

When an engine is properly lubricated, all of the moving parts glide on a thin film of oil. If that film breaks down or carries enough grit to bridge the film, damage will occur.

1. When the parts are at rest, they push the lubricant or oil away resting on the bearing surfaces. As the parts rotate, they climb over the oil, pulling the oil between the bearing and the part, riding on a film of oil.

The asperities are the first thing to make contact between two moving engine parts with an insufficient oil film between them. This creates friction and causes a transfer of metal between the parts. The heat and friction further breaks down the oil film, accelerating the process.

2. Insufficient lubrication failures include:

- Low oil level
- Wrong oil for the application
- Contaminated oil
- Degraded oil (heat, age, acids)

3. Metal transfer is the primary indicator that the film of oil between two engine parts has been violated.

If the damage is localized, a general failure of the lubrication system is probably not the cause.

As an example: a piston skirt shows metal transfer to the cylinder wall. The connecting rod and wristpin show some signs of excessive heat. The main bearings and camshaft are not damaged. This would indicate that the problem was probably related to cylinder temperature.

The hall mark of a lubrication failure is the presence of discoloration and/or metal transfer on all friction surfaces within the engine.

See Figure 11.8.

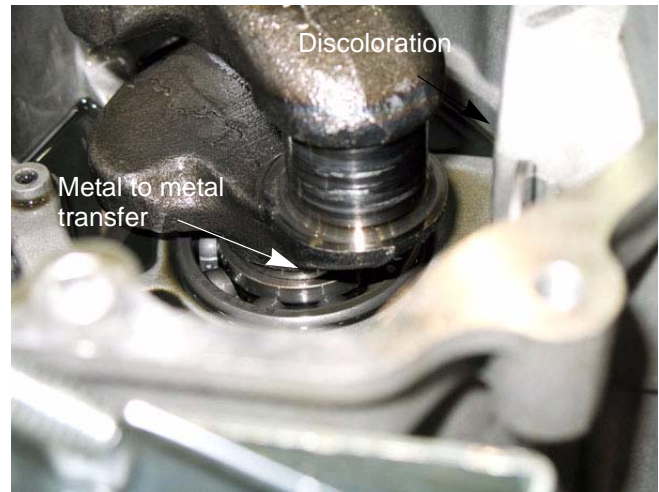

Figure 11.8

An important thing to note is that just because there are signs of insufficient lubrication, that does not mean that was the cause of the failure. It may only be a symptom of the real cause of the failure.

Larger size abrasive particles can render the lubricants ineffective, leading to an engine failure. An overheated engine can cause the oil to break down leading to a failure. In an engine overspeed, the oil is pushed away from the bearing surface leading to a failure.

In all three of the above cases, the signs of insufficient lubrication are symptoms not the cause. There will also be signs of heat or discoloration around the parts affected by the lack of lubrication. See Figure 11.9.

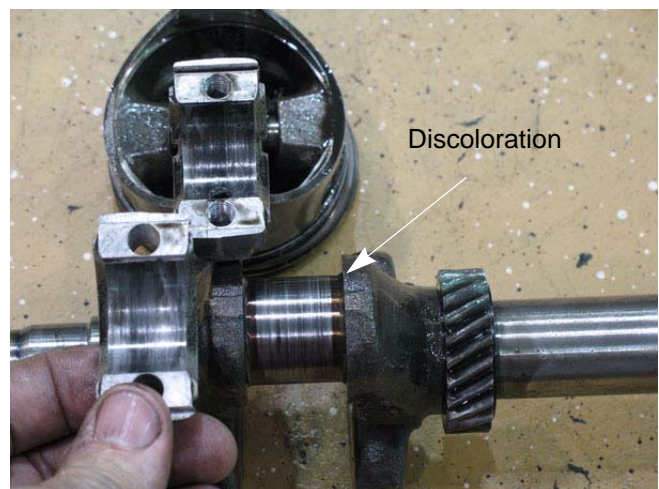

Figure 11.9

Engine Overspeed

The MTD engine is designed for a maximum speed of 3600 rpm. When the governor is unable to control the engine rpm the engine can accelerate past the safe maximum speed.

When an engine runs beyond its designed speed a few things happen:

1. As the piston moves up and down in the cylinder it builds momentum. The higher the rpm's the more momentum produced by the pistons. As the momentum builds, the connecting rods will start to stretch. When the connecting rods stretch, they get weaker. Generally speaking this is at the narrowest part of the connecting rods. On most engine that would be about an inch below the wrist pin, but on the MTD engine it is at the wrist pin.

The force on the connecting rod is greatest when the piston transitions from the upward stroke to the downward stroke. Because of this, most overspeed connecting rod failures will occur with the piston at top dead center.

When a connecting rod fails, the piston stops moving but the crankshaft is still moving. This will allow the broken connecting rod to get knocked around in the cylinder causing more damage to it. Usually the connecting rod will be in several pieces after it breaks making it hard to find where the first failure was.

2. All engines have vibrations and are designed to handle those vibrations, but in overspeed the vibrations change resonance. Parts that can not handle the new resonance will crack. This may result in parts flying off of the engine which is an unsafe condition such as when a flywheel shatters and pieces of it fly off of the engine.

The vibration can also lead to fasteners loosening up. Evidence of this could be elongated mounting holes. The area around the mounting holes may be polished due to the two surfaces rubbing against each other. See Figure 11.10.



Figure 11.10

NOTE: The vibration can also be caused by a loose implement or blade.

3. When an engine overspeeds, the moving parts can not pull the oil in between them. This allows metal to metal contact. Because of this, signs of inadequate lubrication will show.
4. When trying to diagnose an overspeed failure, look at all the pieces. Individually the lack of lubrication, piston position and condition of the connection rod will usually indicate separate failures. Collectively they would indicate an overspeed failure.

Chapter 11: Failure Analysis

Overheated

The MTD engines are air cooled engines. Because of this, cleanliness of the engine is very important to the life of the engine. Dirt, grass and sludge all form an insulating layer on the engine. This will trap the heat in the engine and cause it to over heat.

As metal parts heat up enough to change their properties, they will take on a yellowish or blue cast.

As oil is heated to the point that it evaporates, black deposits are left behind. This is called "coking". An engine with lots of coked oil deposits inside the crankcase or cylinder head indicates that it has been over heated. See Figure 11.11.



Figure 11.11

Another sign of an overheat failure is warped parts. As metal parts heat up, they expand. In an engine a certain amount of expansion is expected. Engines are built so that when parts are at operating temperature, the parts will expand to be within the tolerances needed for the engine to run. A problem occurs when the parts are over heated. They expand more than they were designed to. Some parts are mounted firmly, like cylinder heads (the hottest part of the engine). As they try to expand, they fight against the head bolts. The head bolts will not move to allow the expansion so the head warps to allow the expansion.

This warping of the head allows the head gasket to leak. A leaking head gasket allows the compressed gases in the engine to escape, lowering the compression in the engine and hurting engine performance. As the cylinder head cools, it shrinks back down to its normal size, but there will still be some warpage of the head. See Figure 11.12.

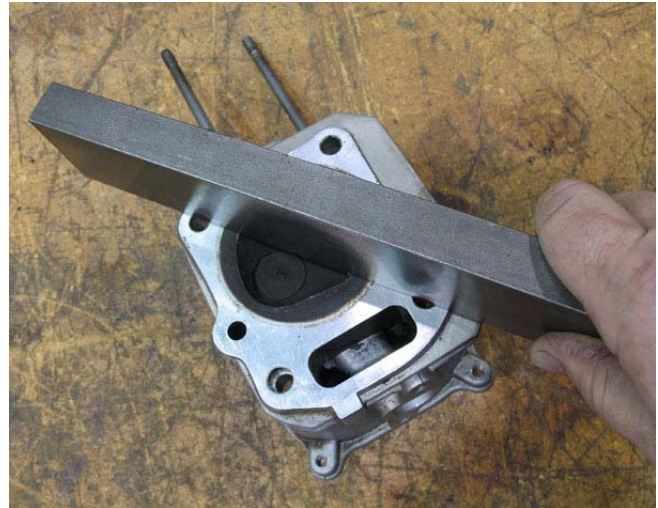

Figure 11.12

Localized over heating will leave localized "hot spot" indications, such as discoloration.

Rapid over heating of a cylinder, like when there is a cooling air flow obstruction, may cause hot spots and metal transfer between the piston skirt and the cylinder wall.

Over heating of the cylinder head maybe caused by lack of air flow or exhaust system issues. Typical damage from this kind of over heating is a dropped valve seat. A dropped exhaust valve seat combined with coked oil in the cylinder head would be sure indicators of an over heated engine.

Mechanical Breakage/ Wear

Sometimes an engine fails because a part breaks. There are generally three causes of a broken part, outside of the previously discussed engine failures. They are abuse, wear, and manufacturing defects.

A very common way to abuse an engine is a bent crankshaft. Crankshafts bend when they, or something bolted to them hits an object. A prime example of this is when a mower blade hits a rock. See Figure 11.13.

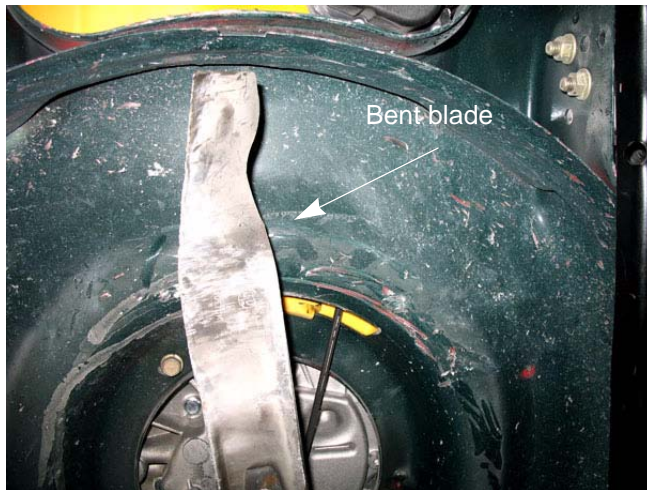

Figure 11.13

As the engine runs, there is friction between the moving parts. This friction wears down the parts. Lubrication slows the process, but wear can not be prevented. Over time the parts wear to the point they break or fail in some way. Car tires are a good example of wear. A tire will only last for so many miles before all the rubber is worn off and the tire goes flat. Bushings are another example, they are designed to wear so that the wear of other parts will be minimized.

Vibration issues have a “chicken and the egg” relationship to mechanical failures. Which came first? Bent crankshafts and imbalanced implements will cause vibration issues. However a vibration issues, such as a over speed or loose mounting bolts on the engine, can shake an engine to pieces. The technician must find the source of the vibration in order to properly diagnosis an engine.

Manufacturing defects are wrongly blamed for alot of failed parts. A manufacturing defect is when a part is made wrong. It could be a porous casting, parts assembled wrong, the wrong parts used or so on. A manufacturing defect will generally show up within the first couple of hours of use.

Detonation/pre-ignition

Detonation is the undesirable condition of the fuel spontaneously combusting in the combustion chamber prior to the spark plug firing. In this state the flame front from the detonation will start to travel through the combustion chamber and a second flame front, from the spark plug, will crash into it. The pressure differential caused by this will send shock waves through the engine. The shock wave cause a knocking or pinging noise. This is why detonation is sometimes called “knocking”, “spark knocking” or “pinging”. The shock wave will also try to push the piston down against the direction of rotation of the crankshaft.

The shock wave from detonation can cause piston failures (melting or breakage), piston skirt damage, connecting rod breakage and in extreme cases crankshaft failures.

A build up of carbon deposits in the combustion chamber will increase the compression ratio. This is a major factor for the development of detonation. It insulates the combustion chamber, allowing it heat up above normal operating temperatures.

Pre-ignition is similar to detonation, but on a smaller scale. Pre-ignition is cause by a localized hot spot or a hot deposit in the cylinder. As the fuel/air mixture is drawn into the cylinder it is ignited. This creates pressure that tries to push the piston down against the direction of rotation of the crankshaft. The sounds and damage created by this is the same as detonation.